



# KOVOVÝ a DRÁTĚNÝ PROGRAM - KATALOG 2016

**ATILA STÝL s.r.o., +420 601 581 817,  
obchod@atilastyl.cz, www.atilastyl.cz**





## Drátěné výrobky

*Očka, háčky, skoby, závlačky, kroužky svařované.....*



1

## Karabiny

*Simplex, DIN 5299, otočné, RAPID, kroužky na klíče.....*



2

## Ocelová lana

*1x19, 6x7+FC, v PVC, 6x19+FC, 6x37+FC a jiné.....*



3

## Příslušenství k ocelovým lanům

*svorky, očnice, objímky AL, kleště lísovací a stříhací.....*



4

## Napínáky, příslušenství

*DIN 1478, DIN 1480, komerční, napínač drátu.....*



5

## Řetězy a dekorativní řetízky

*DIN766, DIN763, DIN5685, uzlované, kroucené, plastové, bezpečnostní, tř.8.....*



6

## Třmeny, otočná oka

*komerční, vysokopevnostní, typ D, Omega, ETR - potrubní, otočná oka.....*



7

## Závěsná oka

*DIN 580, DIN 582.....*



8

## Vázací háky, komponenty tř.8

*DIN 689, typ 320A, typ 322A, vlečný, komponenty tř.8 pro vazáky.....*



9

## Kladky

*jednoduché, dvojitě, montážní, stavební.....*



10

## Kotevní prvky

*kotvy, hmoždinky, stahovací pasky, příchytky kabelové.....*



11

## Nábytkové příslušenství

*závěsy, zástrče, háčky, policové kolíky, podpěry, konzoly.....*



12

## Tesařské a spojovací kování

*úhelníky, plechy, rohovníky, zemní vruty.....*



13

## Uzávěry, petlice a rukojeti

*pákové uzávěry, petlice, rukojeti na bedny.....*



14

## Textilní lana, šňůry a popruhy

*PA, PES, PP, přírodní materiály.....*



15

atILa  
RTVI



# Drátěné výrobky

---

*Small rigging*

# 1 Oko s vrutem

**povrch:** galvanický zinkochromát (bílý) > 8µm  
**materiál:** ocel S235JR, pevn.tř.4.6, Re 235MPa

**Screw eye**

**finish:** galvanized > 8µm  
**material:** carbon steel St 37-2

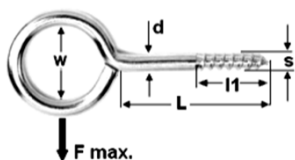

Kód Art. No.	L mm	w mm	d mm	l1 mm	 mm	F max* kg	kg/100ks kg/100pcs	balení/ks bag/pcs	karton/ks carton/pcs
1200.0603	6	3	1,6	4	3	2,5	0,03	300	15 000
1200.0804	8	4	2,1	5	4	5,0	0,06	300	15 000
1200.1004	10	4	2,2	7	4	7,5	0,10	200	15 000
1200.1206	12	6	2,8	7	5	10,0	0,19	200	7 500
1200.1606	16	6	3,1	10	5	10,0	0,24	200	7 500
1200.1608	16	8	3,2	11	6	10,0	0,27	100	7 500
1200.2008	20	8	3,2	12	6	12,5	0,33	100	5 000
1200.2010	20	10	3,2	12	6	12,5	0,42	100	5 000
1200.2012	20	12	3,5	14	6	10,0	0,37	100	5 000
1200.2510	25	10	3,2	16	6	12,5	0,46	100	5 000
1200.2512	25	12	3,5	16	6	20,0	0,71	100	2 500
1200.2514	25	14	3,8	16	6	20,0	0,75	100	2 500
1200.3010	30	10	3,2	15	6	12,5	0,50	100	2 500
1200.3012	30	12	3,8	16	6	20,0	0,74	100	2 500
1200.3014	30	14	3,8	18	6	15,0	0,64	100	2 500
1200.3016	30	16	4,2	16	8	20,0	1,01	100	2 000
1200.3516	35	16	4,4	18	8	25,0	1,18	100	1 700
1200.4014	40	14	3,8	22	6	20,0	0,95	100	2 500
1200.4016	40	16	4,2	22	8	20,0	1,11	100	2 000
1200.4018	40	18	4,7	22	8	25,0	1,58	100	1 500
1200.4517	45	17	4,4	25	8	25,0	1,35	100	1 500
1200.5016	50	16	4,2	25	8	20,0	1,21	50	2 000
1200.5018	50	18	4,7	25	8	25,0	1,71	50	1 500
1200.5020	50	20	5,2	25	10	35,0	2,08	50	1 000
1200.6025	60	25	5,8	32	10	50,0	3,15	50	750

**povrch:** pomosazený >8µm

**finish:** brass plated >8µm

Kód Art. No.	L mm	w mm	d mm	l1 mm	 mm	F max* kg	kg/100ks kg/100pcs	balení/ks bag/pcs	karton/ks carton/pcs
1201.1206	12	6	2,0	7	4	5,0	0,08	200	7 500
1201.1608	16	8	3,0	11	6	10,0	0,27	200	7 500
1201.2012	20	12	3,0	14	6	10,0	0,37	100	5 000
1201.3014	30	14	3,6	18	6	15,0	0,64	100	2 500
1201.3516	35	16	4,4	18	8	20,0	1,18	100	1 700
1201.4517	45	17	4,4	25	8	20,0	1,35	50	1 500

**povrch:** bíle lakovaný

**finish:** white painted

Kód Art. No.	L mm	w mm	d mm	l1 mm	 mm	F max* kg	kg/100ks kg/100pcs	balení/ks bag/pcs	karton/ks carton/pcs
1202.1608	16	8	3,0	11	6	10	0,27	100	5 000
1202.2012	20	12	3,0	14	6	10	0,37	100	5 000
1202.3014	30	14	3,6	18	6	15	0,64	50	2 500

**materiál:** nerezavějící ocel A2

**material:** stainless steel AISI 304



Kód Art. No.	L mm	w mm	d mm	l1 mm	 mm	F max* kg	kg/100ks kg/100pcs	balení/ks bag/pcs	karton/ks carton/pcs
9200.1608	16	8	3,2	10	6	10	0,31	50	500
9200.2010	20	10	3,2	12	6	10	0,42	50	500
9200.2512	25	12	3,8	16	6	20	0,71	25	500
9200.3014	30	14	3,8	16	6	20	0,77	25	500

## Oko s metrickým závitem

**povrch:** galvanický zinkochromát (bílý) > 8µm  
**materiál:** ocel S235JR, pevn.tř.4.6, Re 235MPa

**Eye with metric thread**

**finish:** galvanized > 8µm  
**material:** carbon steel St 37-2

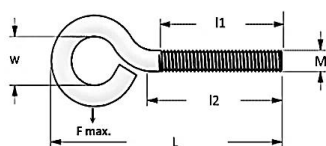

Kód Art. No.	M x l2 thread	l1 mm	L mm	w mm	d mm	F max* kg	kg/100ks kg/100pcs	balení/ks bag/pcs	karton/ks carton/pcs
1207.041	M4x10	10	25	6	3,3	12	0,32	100	5 000
1207.042	M4x20	20	35	6	3,3	12	0,38	100	5 000
1207.043	M4x30	30	45	6	3,3	12	0,46	100	4 000
1207.044	M4x40	40	55	6	3,3	12	0,53	100	4 000
1207.051	M5x10	10	30	8	4,2	20	0,53	100	3 500
1207.052	M5x20	20	40	8	4,2	20	0,69	100	3 500
1207.053	M5x30	30	50	8	4,2	20	0,88	100	2 000
1207.054	M5x40	40	60	8	4,2	20	1,00	100	2 000
1207.055	M5x50	50	70	8	4,2	20	1,12	100	2 000
1207.056	M5x60	60	80	8	4,2	20	1,24	100	1 500
1207.062	M6x20	20	45	10	5,0	35	1,17	100	2 000
1207.063	M6x30	30	55	10	5,0	35	1,33	100	1 500
1207.064	M6x40	40	65	10	5,0	35	1,49	100	1 500
1207.065	M6x50	50	75	10	5,0	35	1,65	100	1 500
1207.066	M6x60	60	85	10	5,0	35	1,81	100	1 000
1207.068	M6x80	80	105	10	5,0	35	2,13	100	1 000
1207.069	M6x100	100	125	10	5,0	35	2,45	100	1 000
1207.082	M8x20	20	50	12	6,8	50	2,45	100	1 000
1207.083	M8x30	30	60	12	6,8	50	2,70	50	750
1207.084	M8x40	40	70	12	6,8	50	3,00	50	750
1207.085	M8x50	50	80	12	6,8	50	3,30	50	750
1207.086	M8x60	60	90	12	6,8	50	3,60	50	750
1207.088	M8x80	80	110	12	6,8	50	4,20	50	500
1207.090	M8x100	100	130	12	6,8	50	4,80	25	500
1207.092	M8x120	100	150	12	6,8	50	5,40	25	500
1207.095	M8x150	100	180	12	6,8	50	6,00	25	400
1207.106	M10x60	60	90	14	8,8	100	6,40	25	250
1207.108	M10x80	80	110	14	8,8	100	7,40	25	250
1207.110	M10x100	100	130	14	8,8	100	8,90	25	250
1207.112	M10x120	100	150	14	8,8	100	9,40	20	200
1207.116	M10x160	100	190	14	8,8	100	11,40	20	200
1207.120	M10x200	100	230	14	8,8	100	13,50	20	160

**materiál:** nerezavějící ocel A2

**material:** stainless steel AISI 304



Kód Art. No.	závit thread	l1 mm	l2 mm	w mm	d mm	F max* kg	kg/100ks kg/100pcs	balení/ks bag/pcs	karton/ks carton/pcs
9207.044	M4	40	55	6	3,3	12	0,53	20	500
9207.052	M5	20	40	8	4,2	20	0,69	20	500
9207.054	M5	40	60	8	4,2	20	1,00	20	500
9207.064	M6	40	65	10	5,0	40	1,49	20	500
9207.066	M6	60	85	10	5,0	40	1,65	20	500

## Oko s metrickým závitem - svařené

**povrch:** galvanický zinkochromát (bílý) > 8µm  
**materiál:** ocel S235JR, pevn.tř.4.6, Re 235MPa

**Eye with metric thread - welded**

**finish:** galvanized > 8µm  
**material:** carbon steel St 37-2

Kód Art. No.	závit mm	l1 mm	L mm	w mm	d mm	F max* kg	kg/100ks kg/100pcs	balení/ks bag/pcs	karton/ks carton/pcs
1208.0605	M6	55	85	10,0	5,0	50	1,81	25	1 200
1208.0806	M8	60	90	11,8	6,8	75	3,60	25	600
1208.0808	M8	80	110	12,0	6,8	75	4,20	20	500
1208.0810	M8	100	130	12,0	6,8	75	4,80	15	500
1208.1007	M10	73	110	14,5	8,9	150	7,60	10	300
1208.1290	M12	95	140	17,0	11,6	250	9,90	10	200

## Oko lešenářské svařované DIN 4420

**povrch:** galvanický zinkochromát (bílý) > 8µm  
**material:** ocel S355JR, pevn.tř.5.6, Re 355MPa

### Welded screw eye DIN 4420

**finish:** galvanized > 8µm  
**material:** carbon steel St 52-3

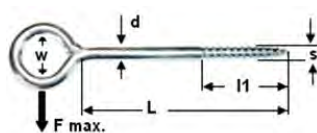

Kód Art. No.	L mm	w mm	d mm	l1 mm	 mm	F max* kg	kg/100ks kg/100pcs	balení/ks bag/pcs	karton/ks carton/pcs
1254.050	50	15	7,8	38	12	80	4,10	25	500
1254.080	80	22	7,8	45	12	80	6,00	25	400
1254.120	120	22	7,8	48	12	80	7,60	25	300
1254.140	140	22	7,8	48	12	80	8,40	25	250
1255.090	90	25	11,8	54	14	500	15,10	20	150
1255.120	120	25	11,8	65	14	500	17,60	20	150
1255.160	160	25	11,8	65	14	500	21,00	20	100
1255.190	190	25	11,8	65	14	500	23,50	10	100
1255.230	230	25	11,8	65	14	500	27,30	10	100
1255.300	300	25	11,8	65	14	500	32,30	10	50
1255.350	350	25	11,8	65	14	500	36,40	10	50

## Oko lešenářské svařované - metrické

**povrch:** galvanický zinkochromát (bílý) > 8µm  
**material:** ocel S355JR, pevn.tř.5.6, Re 355MPa  
 ISO - závit, svařené oko

### Screw eyes for scaffoldings

**finish:** galvanized > 8µm  
**material:** carbon steel St 52-3  
 with ISO-thread, eye welded

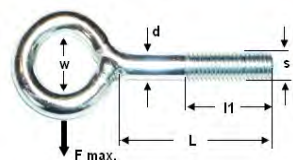

Kód Art. No.	s mm	L mm	l1 mm	d mm	w mm	F max* kg	kg/100ks kg/100pcs	balení/ks bag/pcs	karton/ks carton/pcs
1246.0806	M8	60	35	7,0	22	50	5,00	25	400
1246.1006	M10	60	35	8,9	23	100	8,00	20	300
1246.1010	M10	100	35	8,9	23	100	9,30	20	240
1246.1014	M10	140	35	8,9	23	100	11,50	10	200
1246.1016	M10	160	35	8,9	23	100	12,20	10	200
1246.1210	M12	100	35	10,6	23	175	12,80	20	200
1246.1212	M12	120	35	10,6	23	175	14,20	10	150
1246.1216	M12	160	35	10,6	23	175	17,00	10	120
1246.1222	M12	220	35	10,6	23	175	21,20	10	100

## Oko lešenářské nesvařované

**povrch:** galvanický zinkochromát (bílý) > 8µm  
**material:** ocel S355JR, pevn.tř.5.6, Re 355MPa

### Screw eyes for scaffoldings

**finish:** galvanized > 8µm  
**material:** carbon steel St 52-3  
 eye not welded

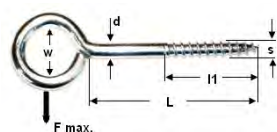

Kód Art. No.	L mm	d mm	l1 mm	w mm	 mm	F max* kg	kg/100ks kg/100pcs	balení/ks bag/pcs	karton/ks carton/pcs
1245.0808	80	7,8	45	22	12	80	6,00	50	400
1245.0810	100	7,8	48	22	12	80	6,80	50	300
1245.0812	120	7,8	48	22	12	80	7,60	25	250
1245.0814	140	7,8	48	22	12	80	8,40	25	250
1245.1012	120	9,9	58	25	14	150	11,70	25	200
1245.1016	160	9,9	58	25	14	150	15,10	20	160
1245.1020	200	9,9	58	25,0	14	150	18,50	20	120



## Skoba s vrutem

**povrch:** galvanický zinkochromát (bílý) > 8µm  
**materiál:** ocel S235JR, pevn.tř.4.6, Re 235MPa

### Square hook

**finish:** galvanized > 8µm  
**material:** carbon steel St 37-2



Kód Art. No.	L mm	d mm	l1 mm	h mm	 mm	F max* kg	kg/100ks kg/100pcs	balení/ks bag/pcs	karton/ks carton/pcs
1210.020	20	2,5	11	6	5	7,5	0,10	300	10 800
1210.025	25	2,5	13	6	5	7,5	0,12	300	10 800
1210.030	30	3,1	14	9	6	10,0	0,19	200	7 200
1210.040	40	3,1	21	11	6	10,0	0,27	200	5 000
1210.050	50	3,5	27	11	6	12,5	0,41	150	3 750
1210.060	60	4,5	30	12	8	15,0	0,83	100	2 000
1210.080	80	5,0	35	16	8	25,0	1,35	100	2 000
1210.100	100	6,0	40	18	10	40,0	2,45	50	1 000

**povrch:** pomosazený 8µm

**finish:** brass plated >8µm

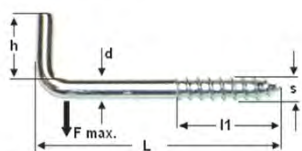

Kód Art. No.	L mm	d mm	l1 mm	h mm	 mm	F max* kg	kg/100ks kg/100pcs	balení/ks bag/pcs	karton/ks carton/pcs
1211.025	25	2,5	13	6	5	7,5	0,12	200	10 800
1211.030	30	3,1	14	9	6	10,0	0,19	200	7 600
1211.040	40	3,1	21	11	6	10,0	0,27	200	5 000
1211.050	50	3,5	27	11	6	12,5	0,41	100	3 750
1211.060	60	4,5	30	12	8	15,0	0,83	100	2 000
1211.080	80	5,0	48	16	8	25,0	1,35	100	2 000

**povrch:** bíle lakovaný

**finish:** white painted

Kód Art. No.	L mm	d mm	l1 mm	h mm	 mm	F max* kg	kg/100ks kg/100pcs	balení/ks bag/pcs	karton/ks carton/pcs
1212.025	25	2,5	13	6	5	7,5	0,12	200	10 800
1212.030	30	3,1	14	9	6	10,0	0,19	200	7 600
1212.040	40	3,1	21	11	6	10,0	0,27	100	5 000
1212.050	50	3,5	27	11	6	12,5	0,41	100	3 750

**materiál:** nerezavějící ocel A2

**material:** stainless steel AISI 304



Kód Art. No.	L mm	w mm	d mm	l1 mm	 mm	F max* kg	kg/100ks kg/100pcs	balení/ks bag/pcs	karton/ks carton/pcs
9210.030	30	3,1	14	9	6	10,0	0,19	50	1 000
9210.040	40	3,1	21	11	6	10,0	0,27	50	1 000
9210.050	50	3,5	27	11	6	12,5	0,41	50	1 000
9210.060	60	4,5	30	12	8	15,0	0,83	25	500
9210.080	80	5,0	48	16	8	25,0	1,35	25	500

## Obrtlík

**povrch:** galvanický zinkochromát (bílý) > 8µm  
**materiál:** ocel S235JR, pevn.tř.4.6, Re 235MPa

### Turn screw

**finish:** galvanized > 8µm  
**material:** carbon steel St 37-2

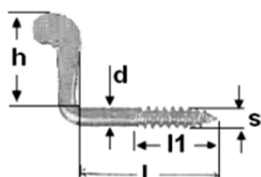

Kód Art. No.	L mm	d mm	l1 mm	h mm	 mm	kg/100ks kg/100pcs	balení/ks bag/pcs	karton/ks carton/pcs
1268.020	20	3,3	15	22	5	0,25	100	5 000
1268.030	30	3,9	18	25	6	0,58	100	3 500
1268.040	40	4,4	23	29	6	1,02	50	2 500
1268.050	50	5,2	30	32	8	1,48	50	1 250

## Skoba s plochou drážkou

**povrch:** galvanický zinkochromát (bílý) > 8µm  
**materiál:** ocel S235JR, pevn.tř.4.6, Re 235MPa

### Slot square hook

**finish:** galvanized > 8µm  
**material:** carbon steel St 37-2

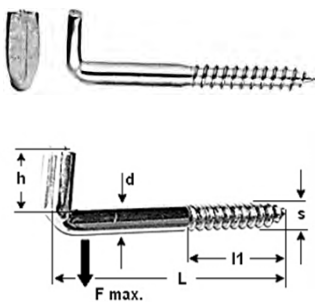

Kód Art. No.	L mm	d mm	l1 mm	h mm	 mm	F max kg	kg/100ks kg/100pcs	balení/ks bag/pcs	karton/ks carton/pcs
1215.030	30	4,2	18	11	8	25	0,41	150	6 000
1215.040	40	4,2	24	11	8	25	0,50	100	4 000
1215.050	50	4,4	24	11	8	30	0,70	100	3 000
1215.065	65	5,8	32	12	10	50	1,40	100	1 500
1215.080	80	5,8	32	12	10	50	1,65	100	1 500
1215.100	100	5,8	35	12	10	50	2,00	50	1 000
1215.120	120	7,0	42	14	10	60	3,20	50	750
1215.150	150	7,0	48	14	10	60	4,10	50	500

## Skoba s křížovou drážkou

**povrch:** galvanický zinkochromát (bílý) > 8µm  
**materiál:** ocel S235JR, pevn.tř.4.6, Re 235MPa

### Cross square hook

**finish:** galvanized > 8µm  
**material:** carbon steel St 37-2

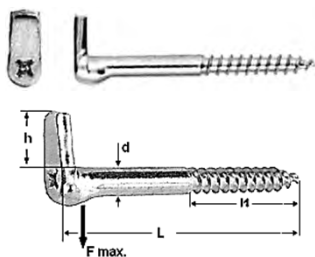

Kód Art. No.	L mm	d mm	l1 mm	h mm	 mm	F max kg	kg/100ks kg/100pcs	balení/ks bag/pcs	karton/ks carton/pcs
1216.040	40	5,2	22	9	8	40	0,75	100	3 500
1216.050	50	5,2	25	9	8	40	0,90	100	3 000
1216.065	65	5,8	32	10	8	50	1,35	50	2 000
1216.080	80	5,8	36	10	8	50	1,70	50	1 500
1216.100	100	5,8	40	10	8	50	1,95	50	1 000

## Skoba s metrickým závitem

**povrch:** galvanický zinkochromát (bílý) > 8µm  
**materiál:** ocel S235JR, pevn.tř.4.6, Re 235MPa

### Square hook with thread

**finish:** galvanized > 8µm  
**material:** carbon steel St 37-2

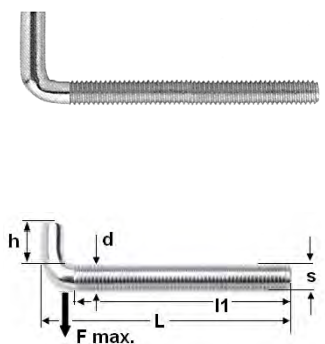

Kód Art. No.	závit thread	L mm	l1 mm	d mm	h mm	F max kg	kg/100ks kg/100pcs	balení/ks bag/pcs	karton/ks carton/pcs
1217.044	M4	40	32	3,5	13	12	0,34	100	7 000
1217.045	M4	50	42	3,5	13	12	0,43	100	5 000
1217.046	M4	60	45	3,5	13	12	0,50	100	5 000
1217.054	M5	40	25	4,4	14	20	0,60	100	3 000
1217.055	M5	50	40	4,4	14	20	0,72	100	3 000
1217.056	M5	60	50	4,4	14	20	0,86	100	2 000
1217.065	M6	50	35	5,3	15	40	1,05	100	2 000
1217.066	M6	60	45	5,3	15	40	1,20	50	2 000
1217.068	M6	80	65	5,3	15	40	1,60	50	1 500
1217.086	M8	60	40	7,0	18	80	2,30	50	1 000
1217.088	M8	80	60	7,0	18	80	3,10	50	750
1217.089	M8	100	80	7,0	18	80	3,90	50	500
1217.095	M8	150	120	7,0	18	80	5,20	25	400

## Skoba zatloukací

**povrch:** galvanický zinkochromát (bílý) > 8µm  
**materiál:** ocel S235JR, pevn.tř.4.6, Re 235MPa

**Nail hook**

**finish:** galvanized > 8µm  
**material:** carbon steel St 37-2

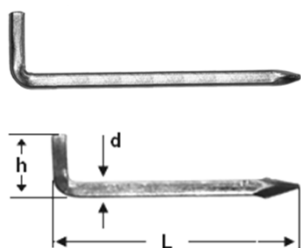

Kód Art. No.	L mm	d mm	h mm	F max kg	kg/100ks kg/100pcs	balení/ks bag/pcs	karton/ks carton/pcs
1218.030	30	3,1	10	10	0,25	300	6 000
1218.040	40	4,0	12	13	0,55	200	5 000
1218.050	50	4,0	14	17	0,70	100	4 000
1218.060	60	4,0	14	17	0,74	100	3 000
1218.080	80	4,6	18	25	1,36	100	2 000
1218.100	100	4,6	18	25	1,59	50	1 000

## Hák rozpěrný s okem

**povrch:** galvanický zinkochromát (bílý) > 8µm  
**materiál:** ocel S235JR, pevn.tř.4.6, Re 235MPa

**Gate hook**

**finish:** galvanized > 8µm  
**material:** carbon steel St 37-2

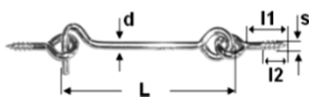

Kód Art. No.	L mm	d mm	l1 mm	l2 mm	s mm	 mm	kg/100ks kg/100pcs	balení/ks bag/pcs	karton/ks carton/pcs
1267.050	50	3,0	18	13	2,8	5	1,10	50	1 500
1267.080	80	3,5	16	12	2,8	5	1,70	50	1 000
1267.100	100	3,7	16	12	3,2	5	2,00	50	1 000
1267.120	120	4,0	20	16	3,6	6	2,70	50	750
1267.140	140	4,5	25	18	4,5	6	4,50	25	500
1267.200	200	5,6	30	20	4,8	8	7,90	25	250
1267.250	250	5,6	30	20	4,8	8	8,70	20	200
1267.300	300	5,6	30	20	4,8	8	9,60	20	200

**materiál:** nerezavějící ocel A2

**material:** stainless steel AISI 304



Kód Art. No.	L mm	d mm	l1 mm	l2 mm	s mm	 mm	kg/100ks kg/100pcs	balení/ks bag/pcs	karton/ks carton/pcs
9267.080	80	3,5	16	12	2,8	5	1,70	50	1 000
9267.100	100	4,0	16	12	3,2	5	1,96	10	500
9267.120	120	4,0	20	16	3,6	6	2,70	50	750
9267.160	160	5,2	25	18	4,5	6	4,60	10	500
9267.200	200	5,6	30	20	4,8	8	7,90	25	250

# 1 Hák s vrutem

**povrch:** galvanický zinkochromát (bílý) > 8µm  
**materiál:** ocel S235JR, pevn.tř.4.6, Re 235MPa

**Cup hook**

**finish:** galvanized > 8µm  
**material:** carbon steel St 37-2



Kód Art. No.	L mm	d mm	w mm	l1 mm		F max* kg	kg/100ks kg/100pcs	balení/ks bag/pcs	karton/ks carton/pcs
1220.020	20	2,1	7	8	4	2,5	0,07	300	14 400
1220.025	25	2,6	7	9	5	5,0	0,13	250	12 500
1220.030	30	3,1	8	13	6	7,0	0,23	200	7 600
1220.040	40	3,1	13	15	6	7,0	0,25	150	3 750
1220.050	50	3,6	19	19	6	12,0	0,58	100	2 000
1220.060	60	4,6	22	20	8	20,0	1,13	100	2 000
1220.070	70	4,6	28	24	8	20,0	1,33	50	1 500
1220.080	80	5,0	30	24	8	35,0	1,84	50	1 000
1220.100	100	6,1	32	40	10	60,0	3,20	50	1 000

**povrch:** pomosazený 8µm

**finish:** brass plated >8µm

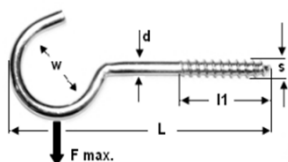

Kód Art. No.	L mm	d mm	w mm	l1 mm		F max* kg	kg/100ks kg/100pcs	balení/ks bag/pcs	karton/ks carton/pcs
1221.020	20	2,1	7	8	4	2,5	0,07	200	14 400
1221.025	25	2,6	7	9,0	5	5,0	0,13	200	12 500
1221.030	30	3,1	8	13	6	7,0	0,23	200	7 600
1221.040	40	3,1	13	15	6	7,0	0,25	100	3 750
1221.050	50	3,6	19	19	6	12,0	0,58	100	2 000
1221.060	60	4,6	22	20	8	20,0	1,13	50	2 000
1221.070	70	4,6	28	24	8	20,0	1,33	50	1 500

**povrch:** bíle lakovaný

**finish:** white painted

Kód Art. No.	L mm	d mm	w mm	l1 mm		F max* kg	kg/100ks kg/100pcs	balení/ks bag/pcs	karton/ks carton/pcs
1222.025	25	2,6	7	9	5	5	0,13	100	12 500
1222.030	30	3,1	8	13	6	7	0,23	100	7 600
1222.040	40	3,1	13	15	6	7	0,25	100	3 750
1222.050	50	3,6	19	19	6	12	0,58	50	2 000

**materiál:** nerezavějící ocel A2

**material:** stainless steel AISI 304



Kód Art. No.	L mm	d mm	w mm	l1 mm		F max* kg	kg/100ks kg/100pcs	balení/ks bag/pcs	karton/ks carton/pcs
9220.040	40	2,9	12	12	6	8	0,36	50	500
9220.050	50	3,2	16	15	6	9	0,48	50	500
9220.060	60	3,2	16	22	6	9	0,64	25	300
9220.080	80	3,8	16	22	6	10	0,95	25	250

# Hák s límcem oplastovaný

**povrch:** galvanický zinkochromát (bílý) > 8µm + vinyl  
**materiál:** ocel S235JR, pevn.tř.4.6, Re 235MPa

**Cup hook with collar**

**finish:** galvanized > 8µm + vinyl  
**material:** carbon steel St 37-2



Kód Art. No.	L mm	d mm	w mm	l1 mm		F max* kg	kg/100ks kg/100pcs	balení/ks bag/pcs	karton/ks carton/pcs
1223.035	35	3,5	11	11	6	10	0,23	100	5 000
1223.050	50	4,5	20	15	8	20	0,61	50	3 000
1223.065	65	5,3	22	20	8	40	0,93	25	2 000

## Hák s metrickým závitem

## Cup hook with thread

**povrch:** galvanický zinkochromát (bílý) > 8µm  
**materiál:** ocel S235JR, pevn.tř.4.6, Re 235MPa

**finish:** galvanized > 8µm  
**material:** carbon steel St 37-2

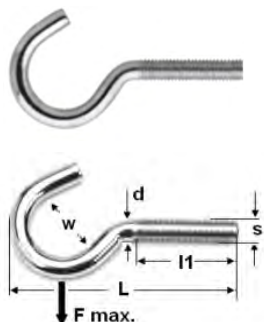

Kód Art. No.	L mm	závit thread	w mm	l1 mm	d mm	F max kg	kg/100ks kg/100pcs	balení/ks bag/pcs	karton/ks carton/pcs
1225.044	40	M4	13	17	3,2	12	0,46	100	4 000
1225.045	50	M4	13	25	3,2	12	0,53	100	4 000
1225.055	50	M5	16	23	4,2	20	0,91	100	2 000
1225.056	60	M5	16	30	4,2	20	1,00	100	2 000
1225.065	50	M6	18	20	5,0	40	1,40	100	1 500
1225.066	60	M6	18	30	5,0	40	1,50	100	1 500
1225.088	80	M8	22	40	6,8	80	3,60	50	750
1225.090	100	M8	25	60	6,8	80	4,60	25	500

## Hák stropní

## Ceiling hook

**povrch:** galvanický zinkochromát (bílý) > 8µm  
**materiál:** ocel S235JR, pevn.tř.4.6, Re 235MPa

**finish:** galvanized > 8µm  
**material:** carbon steel St 37-2

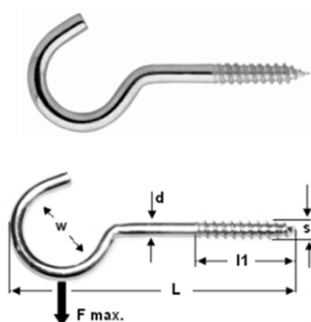

Kód Art. No.	L mm	d mm	w mm	l1 mm	 mm	F max* kg	kg/100ks kg/100pcs	balení/ks bag/pcs	karton/ks carton/pcs
1230.060	60	4,0	16	18	8	15	0,81	150	3 000
1230.080	80	4,0	16	37	8	15	0,96	100	2 000
1230.100	100	5,0	16	47	8	35	1,90	100	2 000
1230.120	120	5,0	16	57	8	35	2,25	50	800
1230.140	140	5,8	16	45	10	60	3,50	50	500
1230.160	160	5,8	16	45	10	60	3,90	50	500

## Hák prádelní

## Clothline hook

**povrch:** galvanický zinkochromát (bílý) > 8µm  
**materiál:** ocel S235JR, pevn.tř.4.6, Re 235MPa

**finish:** galvanized > 8µm  
**material:** carbon steel St 37-2



Kód Art. No.	L mm	d mm	w mm	l1 mm	 mm	F max* kg	kg/100ks kg/100pcs	balení/ks bag/pcs	karton/ks carton/pcs
1231.050	50	4,5	16	16,0	8	20	0,80	100	2 500
1231.065	65	5,0	22	21	8	35	1,30	100	1 500
1231.080	80	5,2	25	24	10	40	1,90	50	1 000
1231.100	100	5,8	25	32	10	60	2,80	50	750

**povrch:** oplastovaný (vinyl)

**finish:** galvanized > 8µm + vinyl

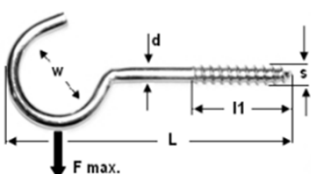

Kód Art. No.	L mm	d mm	w mm	l1 mm	 mm	F max kg	kg/100ks kg/100pcs	balení/ks bag/pcs	karton/ks carton/pcs
1233.050	50	5	16	16	8	20	0,85	50	2 500
1233.065	65	5	22	21	8	35	1,35	50	1 500
1233.080	80	5	25	24	10	40	1,95	25	1 000
1233.100	100	6	25	32	10	60	2,90	25	750

## Oko se závitem a kroužkem

**povrch:** galvanický zinkochromát (bílý) > 8µm  
**materiál:** ocel S235JR, pevn.tř.4.6, Re 235MPa

**Ringbolt with thread**

**finish:** galvanized > 8µm  
**material:** carbon steel St 37-2



Kód Art. No.	L mm	závit thread	d x w mm	d2 mm	l1 mm	F max* kg	kg/100ks kg/100pcs	balení/ks bag/pcs	karton/ks carton/pcs
1256.008	80	M8	7 x 50	6,8	50	100	10,2	20	200
1256.010	100	M10	9 x 45	8,8	65	200	16,2	10	150
1256.012	120	M12	9 x 45	10,5	90	300	23,1	10	100

**materiál:** nerezavějící ocel A4

**material:** stainless steel AISI 316

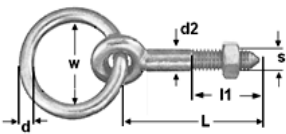

Kód Art. No.	L mm	závit thread	d x w mm	d2 mm	l1 mm	F max* kg	kg/100ks kg/100pcs	balení/ks bag/pcs	karton/ks carton/pcs
9256.008	80	M8	8 x 45	6,8	50	100	12,5	1	200
9256.012	120	M10	9 x 50	8,8	75	200	17,0	1	150

## Oko s vrutem a kroužkem

**povrch:** galvanický zinkochromát (bílý) > 8µm  
**materiál:** ocel S235JR, pevn.tř.4.6, Re 235MPa

**Ringbolt with screw**

**finish:** galvanized > 8µm  
**material:** carbon steel St 37-2



Kód Art. No.	L mm	w mm	d2 mm	l1 mm	d mm	 mm	kg/100ks kg/100pcs	balení/ks bag/pcs	karton/ks carton/pcs
1257.006	60	45	6	30	5	10	5,0	20	400
1257.008	80	50	8	50	7	12	11,0	20	200
1257.010	95	50	10	60	9	14	18,2	10	100

**materiál:** nerezavějící ocel A4

**material:** stainless steel AISI 316

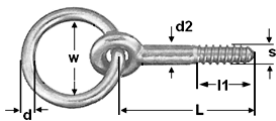

Kód Art. No.	L mm	w mm	d2 mm	l1 mm	d mm	 mm	kg/100ks kg/100pcs	ks pcs	ks pcs
9257.006	80	40	6	30	6	10	5,0	1	400
9257.008	80	45	8	40	8	12	10,5	1	200

## Zástrčka pružná jednoduchá

**povrch:** galvanický zinkochromát (bílý) > 8µm  
**materiál:** ocel S355JR, pevn.tř.5.6, Re 355MPa

**Spring pin single**

**finish:** galvanized > 8µm  
**material:** carbon steel St 52-3

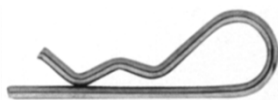

Kód Art. No.	d1 mm	l1 mm	l2 mm	d2 mm	rozsah mm	kg/100ks kg/100pcs	balení/ks bag/pcs	karton/ks carton/pcs
1261.02	2	42	24	12	8-14	0,27	100	5 000
1261.03	3	62	35	18	10-16	0,87	100	2 500
1261.04	4	64	35	20	16-20	1,52	50	1 500
1261.05	5	86	50	26	20-28	3,30	50	750
1261.06	6	102	55	32	28-40	5,90	50	400
1261.07	7	108	62	32	28-45	8,00	25	250
1261.08	8	120	62	32	30-45	11,50	10	200

**materiál:** nerezavějící ocel A2

**material:** stainless steel AISI 304

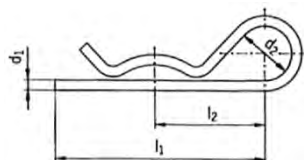

Kód Art. No.	d1 mm	l1 mm	l2 mm	d2 mm	rozsah mm	kg/100ks kg/100pcs	balení/ks bag/pcs	karton/ks carton/pcs
9261.02	2	42	24	12	8-14	0,27	20	500
9261.03	3	62	35	18	10-16	0,87	20	500
9261.04	4	64	35	20	16-20	1,52	10	500
9261.05	5	86	50	26	20-28	3,30	10	300
9261.06	6	102	55	32	28-40	5,90	5	200

## Zástrčka pružná dvojitá DIN 11024

**povrch:** galvanický zinkochromát (bílý) > 8µm  
**materiál:** ocel S355JR, pevn.tř.5.6, Re 355MPa

**Spring pin double**

**finish:** galvanized > 8µm  
**material:** carbon steel St 52-3

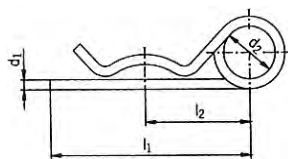

Kód Art. No.	d1 mm	l1 mm	l2 mm	d2 mm	rozsah mm	kg/100ks kg/100pcs	balení/ks bag/pcs	karton/ks carton/pcs
1262.02	2	38	20	10	8-14	0,33	50	3 000
1262.03	3	63	34	17	14-20	1,08	50	1 200
1262.04	4	75	45	21	17-24	2,42	50	500
1262.05	5	90	53	27	18-30	4,65	25	300
1262.06	6	122	72	30	24-36	9,40	25	200
1262.07	7	125	70	30	26-40	12,30	10	150

## Kolík pojistný

**povrch:** galvanický zinkochromát (bílý) > 8µm  
**materiál:** ocel S355JR, pevn.tř.5.6, Re 355MPa

**Lynch pin**

**finish:** galvanized > 8µm  
**material:** carbon steel St 52-3

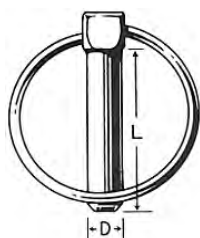

Kód Art. No.	D mm	L mm				kg/100ks kg/100pcs	balení/ks bag/pcs	karton/ks carton/pcs
1263.04	4,5	36				1,26	50	1 500
1263.06	6,0	40				2,04	50	1 000
1263.08	8,0	44				2,85	50	750
1263.09	9,0	42				3,30	50	500
1263.10	10,0	44				4,10	50	500
1263.11	11,0	44				4,60	50	500

## Kolík pojistný trubkový

**povrch:** galvanický zinkochromát (bílý) > 8µm  
**materiál:** ocel S355JR, pevn.tř.5.6, Re 355MPa

**Lynch pin for pipes**

**finish:** galvanized > 8µm  
**material:** carbon steel St 52-3

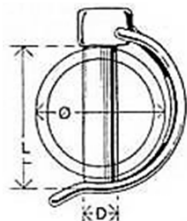

Kód Art. No.	D mm	L mm	Ø mm	kg/100ks kg/100pcs	balení/ks bag/pcs	karton/ks carton/pcs
1273.0432	4,5	32	28	1,95	50	1 000
1273.0640	6,0	40	36	2,60	50	750
1273.0645	6,0	45	40	2,70	50	750
1273.0840	8,0	40	36	4,20	50	500
1273.0845	8,0	45	40	4,30	50	500
1273.0850	8,0	50	45	4,40	50	500
1273.1045	10,0	45	40	5,80	50	300
1273.1050	10,0	50	45	6,00	50	300

## S - hák

**povrch:** galvanický zinkochromát (bílý) > 8µm  
**materiál:** ocel S235JR, pevn.tř.4.6, Re 235MPa

**S - hook**

**finish:** galvanized > 8µm  
**material:** carbon steel St 37-2



Kód Art. No.	L mm	D mm	C mm	nosnost WLL kg	kg/100ks kg/100pcs	balení/ks bag/pcs	karton/ks carton/pcs
1264.03	30	3	5	15	0,36	200	5 000
1264.04	35	4	7	25	0,72	100	3 000
1264.05	45	5	9	40	1,40	100	1 500
1264.06	55	6	12	65	2,40	100	750
1264.07	65	7	14	90	3,80	50	500
1264.08	75	8	16	120	5,80	50	300
1264.10	90	10	18	200	10,60	25	200

**materiál:** nerezavějící ocel A2

**material:** stainless steel AISI 304

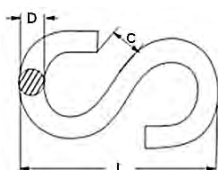

Kód Art. No.	L mm	D mm	C mm	nosnost WLL kg	kg/100ks kg/100pcs	balení/ks bag/pcs	karton/ks carton/pcs
9264.03	30	3	5	15	0,36	50	1 000
9264.04	35	4	7	25	0,72	50	1 000
9264.05	45	5	9	40	1,40	20	500
9264.06	55	6	12	65	2,40	20	500
9264.08	75	8	16	120	5,80	10	300

## Hák řeznický

**materiál:** nerezavějící ocel A2

**Meat hook**

**material:** stainless steel AISI 304

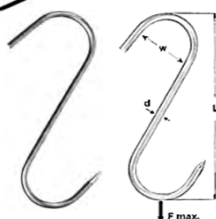

Kód Art. No.	L mm	d mm	w mm	F max* kg	kg/100ks kg/100pcs	balení/ks bag/pcs	karton/ks carton/pcs
9266.080	80	3,9	27	20	1,30	20	1 200
9266.100	100	4,4	32	30	2,20	20	1 000
9266.120	120	4,8	35	40	3,00	20	700
9266.140	140	5,5	40	50	3,80	10	500
9266.160	160	5,8	44	60	5,90	10	400
9266.180	180	6,5	48	70	6,90	10	300



## Kroužek svařovaný

**povrch:** galvanický zinkochromát (bílý) > 8µm  
**materiál:** ocel S235JR, pevn.tř.4.6, Re 235MPa

**Welded ring**

**finish:** galvanized > 8µm  
**material:** carbon steel St 37-2



Kód Art. No.	C mm	A mm				nosnost WLL kg	kg/100ks kg/100pcs	balení/ks bag/pcs	karton/ks carton/pcs
1269.032	20	3				30	0,35	100	5 000
1269.035	25	4				40	0,67	100	3 000
1269.043	30	4				60	0,95	100	2 000
1269.053	30	5				100	1,70	100	1 000
1269.054	40	5				100	2,05	100	1 000
1269.064	40	6				150	3,00	100	750
1269.065	50	6				150	3,60	100	600
1269.073	35	7				200	3,70	50	600
1269.075	50	7				200	5,10	50	400
1269.085	50	8				300	6,80	50	300
1269.086	60	8				300	8,00	50	250
1269.088	80	8				300	10,60	25	200
1269.096	60	9				400	10,30	25	200
1269.105	50	10				500	10,80	25	200
1269.108	80	10				500	17,20	20	100
1269.126	60	12				800	18,90	20	100
1269.130	100	12				800	30,00	10	60

**materiál:** nerezavějící ocel A4

**material:** stainless steel AISI 316



Kód Art. No.	C mm	A mm				nosnost WLL kg	kg/100ks kg/100pcs	balení/ks bag/pcs	karton/ks carton/pcs
9269.043	30	4				60	0,95	20	1 000
9269.054	40	5				100	2,05	20	800
9269.065	50	6				150	3,60	10	500
9269.086	60	8				300	8,00	10	250
9269.105	50	10				500	13,50	5	150
9269.108	80	10				500	17,20	1	100
9269.130	100	12				800	23,50	1	60

## D - kroužek svařovaný

**povrch:** galvanický zinkochromát (bílý) > 8µm  
**materiál:** ocel S235JR, pevn.tř.4.6, Re 235MPa

**Welded D ring**

**finish:** galvanized > 8µm  
**material:** carbon steel St 37-2



Kód Art. No.	B mm	A mm	C mm			nosnost WLL kg	kg/100ks kg/100pcs	balení/ks bag/pcs	karton/ks carton/pcs
1270.032	20	3,5	17			60	0,53	100	4 000
1270.042	25	4,0	22			100	0,90	100	2 000
1270.053	30	5,0	22			150	1,50	100	1 500
1270.064	40	6,0	37			200	2,95	100	800
1270.075	50	7,0	51			300	5,40	50	400
1270.086	60	8,0	63			400	9,50	50	200

**materiál:** nerezavějící ocel A4

**material:** stainless steel AISI 316

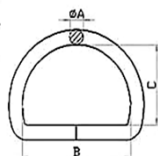

Kód Art. No.	B mm	A mm	C mm			nosnost WLL kg	kg/100ks kg/100pcs	balení/ks bag/pcs	karton/ks carton/pcs
9270.043	30	4	25			100	1,13	20	800
9270.054	40	5	30			150	2,25	20	600
9270.065	50	6	40			200	3,40	10	400

## Článek nouzový

**povrch:** galvanický zinkochromát (bílý) > 8µm  
**materiál:** ocel S235JR, pevn.tř.4.6, Re 235MPa

**Lap link**

**finish:** galvanized > 8µm  
**material:** carbon steel St 37-2

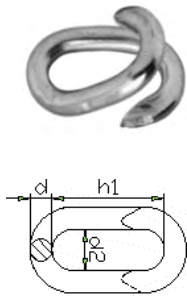

Kód Art. No.	h1 mm	d mm	d2 mm			kg/100ks kg/100pcs	balení/ks bag/pcs	karton/ks carton/pcs
1272.03	17	3	7			0,39	100	4 000
1272.04	20	4	8			0,78	100	2 000
1272.05	23	5	10			1,55	100	1 000
1272.06	29	6	12			2,60	50	750
1272.08	37	8	15			5,60	50	400
1272.10	37	10	18			9,50	25	200

## Deska s okem

**povrch:** galvanický zinkochromát (bílý) > 8µm  
**materiál:** ocel S235JR, pevn.tř.4.6, Re 235MPa

**Pad eye with plate**

**finish:** galvanized > 8µm  
**material:** carbon steel St 37-2



Kód Art. No.	L mm	B mm	A mm	d mm	C mm		kg/100ks kg/100pcs	balení/ks bag/pcs	karton/ks carton/pcs
1290.06	40	35	18	6	18		4,00	20	400
1290.08	55	55	22	8	22		8,70	10	200

**materiál:** nerezavějící ocel A4

**material:** stainless steel AISI 316

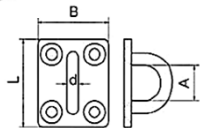

Kód Art. No.	L mm	B mm	A mm	d mm	C mm		kg/100ks kg/100pcs	balení/ks bag/pcs	karton/ks carton/pcs
9290.06	40	35	18	6	18		4,00	5	400
9290.08	55	55	22	8	22		8,70	5	200

## Deska s okem a kroužkem

**povrch:** galvanický zinkochromát (bílý) > 8µm  
**materiál:** ocel S235JR, pevn.tř.4.6, Re 235MPa

**Plate with eye and ring**

**finish:** galvanized > 8µm  
**material:** carbon steel St 37-2



Kód Art. No.	D / d mm	L mm	B mm	A mm	C mm	Ø mm	kg/100ks kg/100pcs	balení/ks bag/pcs	karton/ks carton/pcs
1291.06	6	40	35	18	18	40	7,10	10	200
1291.08	8	55	55	22	22	50	15,90	5	100

**materiál:** nerezavějící ocel A4

**material:** stainless steel AISI 316

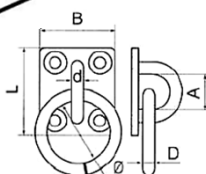

Kód Art. No.	D / d mm	L mm	B mm	A mm	C mm	Ø mm	kg/100ks kg/100pcs	balení/ks bag/pcs	karton/ks carton/pcs
9291.06	6	40	35	18	18	40	7,10	5	200
9291.08	8	55	55	22	22	50	15,90	5	100

## Hák houpačkový s vrutem

**povrch:** galvanický zinkochromát (bílý) > 8µm  
**materiál:** ocel S235JR, pevn.tř.4.6, Re 235MPa

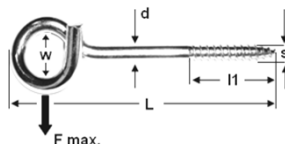

### Ceiling hook with screw

**finish:** galvanized > 8µm  
**material:** carbon steel St 37-2



Kód Art. No.	L mm	l1 mm	w mm	d mm	s mm	F max* kg	kg/100ks kg/100pcs	balení/ks bag/pcs	karton/ks carton/pcs
1280.008	120	50	23	7,6	9,2	100	7,2	20	240
1280.009	140	60	26	8,6	10,6	150	10,6	20	160
1280.011	160	70	26	10,6	12,4	250	13,2	10	120

## Hák houpačkový se závitem

**povrch:** galvanický zinkochromát (bílý) > 8µm  
**materiál:** ocel S235JR, pevn.tř.4.6, Re 235MPa

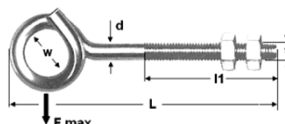

### Ceiling hook with thread

**finish:** galvanized > 8µm  
**material:** carbon steel St 37-2



Kód Art. No.	L mm	závit thread	l1 mm	w mm	d mm	F max* kg	kg/100ks kg/100pcs	balení/ks bag/pcs	karton/ks carton/pcs
1281.008	120	M8	60	23	6,8	80	7,2	20	300
1281.010	150	M10	80	26	8,8	150	12,5	20	160
1281.012	180	M12	100	26	10,6	250	21,1	10	100

## Hák houpačkový s vrutem a objímkou

**povrch:** galvanický zinkochromát (bílý) > 8µm  
**materiál:** ocel S235JR, pevn.tř.4.6, Re 235MPa



### Swinging hook with screw

**finish:** galvanized > 8µm  
**material:** carbon steel St 37-2



Kód Art. No.	L mm	l1 mm	d mm	d2 mm	s mm	F max* kg	kg/100ks kg/100pcs	balení/ks bag/pcs	karton/ks carton/pcs
1282.180	180	75	10,6	8,0	12,4	150	23,6	10	100

## Hák houpačkový se závitem a objímkou

**povrch:** galvanický zinkochromát (bílý) > 8µm  
**materiál:** ocel S235JR, pevn.tř.4.6, Re 235MPa

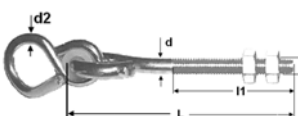

### Swinging hook with thread

**finish:** galvanized > 8µm  
**material:** carbon steel St 37-2



Kód Art. No.	L mm	závit thread	l1 mm	d2 mm	d mm	F max* kg	kg/100ks kg/100pcs	balení/ks bag/pcs	karton/ks carton/pcs
1283.180	140	M12	100	8	10,6	150	26,5	10	100
1283.250	190	M12	150	8	10,6	150	32,2	10	60

1

## Hák houpačkový s karabinou

**povrch:** galvanický zinkochromát (bílý) > 8µm  
**materiál:** ocel S235JR, pevn.tř.4.6, Re 235MPa

**Swinging hook with snap hook**

**finish:** galvanized > 8µm  
**material:** carbon steel St 37-2

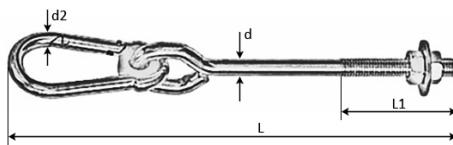

Kód Art. No.	L mm	závit thread	l1 mm	d2 mm	d mm	F max* kg	kg/100ks kg/100pcs	balení/ks bag/pcs	karton/ks carton/pcs
1284.230	230	M12	70	10	10,6	250	31,4	10	60
1284.280	280	M12	150	10	10,6	250	33,2	10	50
1284.350	350	M12	200	10	10,6	250	33,2	10	50

## Hák houpačkový s karabinou - vrut

**povrch:** galvanický zinkochromát (bílý) > 8µm  
**materiál:** ocel S235JR, pevn.tř.4.6, Re 235MPa

**Swinging hook with snap hook - screw**

**finish:** galvanized > 8µm  
**material:** carbon steel St 37-2

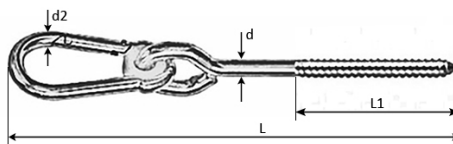

Kód Art. No.	L mm	závit thread	l1 mm	d2 mm	d mm	F max* kg	kg/100ks kg/100pcs	balení/ks bag/pcs	karton/ks carton/pcs
1284.V23	230	vrut	75	10	10,6	250	23,5	10	80
1284.V28	280	screw	100	10	10,6	250	28,5	10	60

## Objímka houpačková s karabinou

**povrch:** galvanický zinkochromát (bílý) > 8µm  
**materiál:** ocel S235JR, pevn.tř.4.6, Re 235MPa

**Collar hook with snap**

**finish:** galvanized > 8µm  
**material:** carbon steel St 37-2

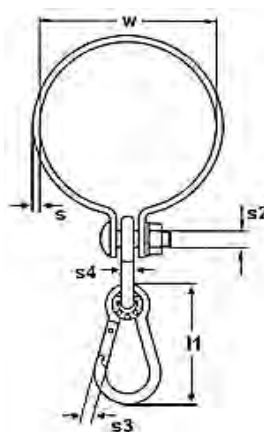

Kód Art. No.	w mm	s2 mm	l1 mm	s mm	s4 mm	F max* kg	kg/100ks kg/100pcs	balení/ks bag/pcs	karton/ks carton/pcs
1285.050	50	M10	100	3,0	7,8	150	36,40	4	50
1285.080	80	M10	100	3,0	7,8	150	42,40	4	50
1285.100	100	M10	100	3,5	7,8	150	53,00	4	50
1285.120	120	M10	100	3,5	7,8	150	62,10	4	40

## Hák houpačkový dvojitý s vrutem

**povrch:** galvanický zinkochromát (bílý) > 8µm  
**materiál:** ocel S235JR, pevn.tř.4.6, Re 235MPa

**Double Ceiling hook with screw**

**finish:** galvanized > 8µm  
**material:** carbon steel St 37-2

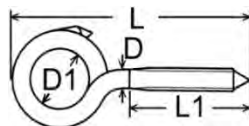

Kód Art. No.	L mm	L1 mm	D1 mm	D mm	F max* kg	kg/100ks kg/100pcs	balení/ks bag/pcs	karton/ks carton/pcs
1286.008	120	50	23	7,8	100	9,9	20	200
1286.010	160	65	25	9,8	250	14,8	10	120

## Hák houpačkový dvojitý se závitem

**povrch:** galvanický zinkochromát (bílý) > 8µm  
**materiál:** ocel S235JR, pevn.tř.4.6, Re 235MPa

**Double Ceiling hook with thread**

**finish:** galvanized > 8µm  
**material:** carbon steel St 37-2

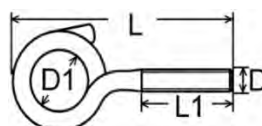

Kód Art. No.	L mm	závit thread	L1 mm	D1 mm	D mm	F max* kg	kg/100ks kg/100pcs	balení/ks bag/pcs	karton/ks carton/pcs
1287.008	120	M8	60	23	7,8	80	9,3	20	250
1287.010	150	M10	80	25	9,8	150	12,8	10	150

## Hák houpačkový s třmenem D+

**povrch:** galvanický zinkochromát (bílý) > 8µm  
**materiál:** ocel S235JR, pevn.tř.4.6, Re 235MPa

**Ceiling hook with shackle D+**

**finish:** galvanized > 8µm  
**material:** carbon steel St 37-2

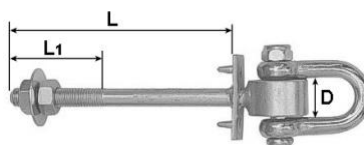

Kód Art. No.	závit thread	L mm	L1 mm	D mm	F max* kg	kg/100ks kg/100pcs	balení/ks bag/pcs	karton/ks carton/pcs
1288.010	M10	140	60	22	150	34,0	6	60
1288.012	M12	160	80	24	250	46,0	4	48





# Karabiny

---

## *Snap hooks*

## Kroužek na klíče

**povrch:** poniklováno

**materiál:** ocel S235JR, pevn.tř.4.6, Re 235MPa

**Key ring**

**finish:** nickel plated

**material:** carbon steel St37-2



Kód Art. No.	AL mm	d1 mm	d2 mm			nosnost WLL kg	kg/100ks kg/100pcs	balení/ks bag/pcs	karton/ks carton/pcs
2400.012	12	1,0	10,0				0,05	500	10 000
2400.016	16	1,2	13,6				0,08	250	10 000
2400.018	18	1,3	15,4				0,11	250	5 000
2400.020	20	1,5	17,0				0,14	250	5 000
2400.025	25	1,6	21,8				0,20	200	4 000
2400.030	30	1,8	26,4				0,40	200	1 000
2400.040	40	2,2	35,6				0,60	100	500
2400.050	50	2,5	45,0				1,00	50	300

## Štítek na klíče

**barva:** mix barev \*

**materiál:** polyamid 6.6 (nylon)

**barvy:** černá, modrá, zelená, červená, fialová, žlutá, oranžová, bílá

**Key label**

**colour:** assorted colours \*

**material:** polyamide 6.6 (nylon)

**colours:** black , blue , green , red , purple , yellow , orange , white



Kód Art. No.	L mm				nosnost WLL kg	kg/100ks kg/100pcs	balení/ks bag/pcs	karton/ks carton/pcs
2401.001	50				5	0,28	200	4 000

\* - jednotlivé barvy na objednání, min. množství 2000ks, dodání 2-3 týdny od objednání

2401.002	50				5	0,28	200	4 000
----------	----	--	--	--	---	------	-----	-------

\* - single colours to order only, minimum quantity 2000pcs, delivery time 2-3 weeks from ordering

## Karabina simplex

**povrch:** poniklováno

**materiál:** ocel S235JR, pevn.tř.4.6, Re 235MPa

**Simplex hook**

**finish:** nickel plated

**material:** carbon steel St37-2

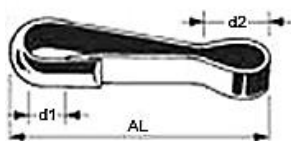

Kód Art. No.	AL mm	d1 mm	d2 mm			nosnost WLL kg	kg/100ks kg/100pcs	balení/ks bag/pcs	karton/ks carton/pcs
2403.030	30	8	6			10	0,22	200	10 000
2403.040	40	9	8			20	0,43	100	5 000
2403.050	50	11	10			40	0,85	100	2 000
2403.060	60	13	11			70	1,56	50	1 000
2403.080	80	13	11			95	2,85	30	700

## Karabina simplex s obrtlíkem

**povrch:** poniklováno

**materiál:** ocel S235JR, pevn.tř.4.6, Re 235MPa

**Simplex hook with swivel**

**finish:** nickel plated

**material:** carbon steel St37-2

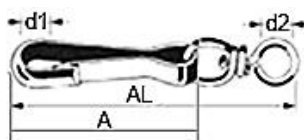

Kód Art. No.	A mm	AL mm	d1 mm	d2 mm		nosnost WLL kg	kg/100ks kg/100pcs	balení/ks bag/pcs	karton/ks carton/pcs
2403.S30	30	50	8	8		5	0,38	100	5 000
2403.S40	40	65	9	10		10	0,69	100	2 500
2403.S50	50	80	11	12		20	1,02	50	1 500
2403.S60	60	100	13	14		30	2,03	50	750



## Karabina hasičská

norma: DIN 5299C

povrch: galvanický zinkochromát (bílý) > 8µm

materiál: ocel S235JR, pevn.tř.4.6, Re 235MPa

**Snap hook DIN 5299C**

finish: galvanized > 8µm

material: carbon steel St37-2



Kód Art. No.	C mm	A mm	D mm	F mm	B mm	nosnost WLL kg	kg/100ks kg/100pcs	balení/ks bag/pcs	karton/ks carton/pcs
2433.004	40	4	6	7	20	70	0,8	100	2500
2433.005	50	5	8	8	25	90	1,6	100	1500
2433.006	60	6	9	8	30	120	2,6	100	1000
2433.007	70	7	11	9	35	180	4,2	50	500
2433.008	80	8	12	10	40	250	6,2	50	400
2433.009	90	9	14	12	45	300	8,9	25	250
2433.010	100	10	16	15	50	350	12,2	25	200
2433.011	120	11	18	19	57	400	17,7	20	120
2433.012	140	12	20	23	65	450	25,3	10	80
2433.013	160	13	22	29	80	500	35,0	10	60
2433.014	180	14	22	35	87	550	45,0	5	50

materiál: nerezavějící ocel A4

material: stainless steel AISI 316

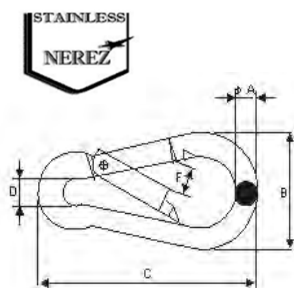

Kód Art. No.	C mm	A mm	D mm	F mm	B mm	nosnost WLL kg	kg/100ks kg/100pcs	balení/ks bag/pcs	karton/ks carton/pcs
9433.004	40	4	6	7	20	70	0,8	10	500
9433.005	50	5	8	8	25	90	1,6	10	500
9433.006	60	6	9	8	30	120	2,6	10	250
9433.007	70	7	11	9	35	180	4,2	10	200
9433.008	80	8	12	10	40	250	6,2	5	150
9433.010	100	10	16	15	50	350	12,2	5	100
9433.011	120	11	18	19	57	400	17,7	1	50
9433.012	140	12	20	23	65	450	25,3	1	40

## Karabina hasičská s pojistkou

norma: DIN 5299D

povrch: galvanický zinkochromát (bílý) > 8µm

materiál: ocel S235JR, pevn.tř.4.6, Re 235MPa

**Snap hook with screw DIN 5299D**

finish: galvanized > 8µm

material: carbon steel St37-2



Kód Art. No.	C mm	A mm	D mm	F mm	B mm	nosnost WLL kg	kg/100ks kg/100pcs	balení/ks bag/pcs	karton/ks carton/pcs
2434.004	40	4	6	7	20	90	0,9	50	2 000
2434.005	50	5	8	8	25	120	1,7	50	1500
2434.006	60	6	9	8	30	160	2,9	50	800
2434.007	70	7	11	9	35	230	4,5	25	400
2434.008	80	8	12	10	40	320	6,8	25	300
2434.009	90	9	14	12	45	370	9,5	20	200
2434.010	100	10	16	15	50	430	13,1	20	200
2434.011	120	11	18	19	57	480	19,3	10	100
2434.012	140	12	20	23	65	540	26,4	5	60

materiál: nerezavějící ocel A4

material: stainless steel AISI 316

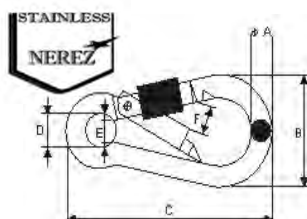

Kód Art. No.	C mm	A mm	D mm	F mm	B mm	nosnost WLL kg	kg/100ks kg/100pcs	balení/ks bag/pcs	karton/ks carton/pcs
9434.005	50	5	8	8	25	120	1,7	10	500
9434.006	60	6	9	8	30	160	2,9	10	300
9434.008	80	8	12	10	40	320	6,8	5	200
9434.010	100	10	14	12	50	430	13,1	5	100

## Karabina hasičská s okem

norma: DIN 5299A

povrch: galvanický zinkochromát (bílý) > 8µm

materiál: ocel S235JR, pevn.tř.4.6, Re 235MPa

**Snap hook with eyelet DIN 5299A**

finish: galvanized > 8µm

material: carbon steel St37-2



Kód Art. No.	C mm	A mm	D mm	F mm	B mm	nosnost WLL kg	kg/100ks kg/100pcs	balení/ks bag/pcs	karton/ks carton/pcs
2435.004	40	4	5	7	20	70	0,8	50	2 000
2435.005	50	5	7	8	25	90	1,6	50	1 400
2435.006	60	6	7	8	30	120	2,7	50	800
2435.007	70	7	8	9	35	180	4,3	25	500
2435.008	80	8	10	10	40	250	6,6	25	300
2435.010	100	10	13	13	50	350	12,8	20	140
2435.011	120	11	13	17	57	400	19,0	10	100
2435.012	140	12	15	19	67	450	25,4	5	80

materiál: nerezavějící ocel A4

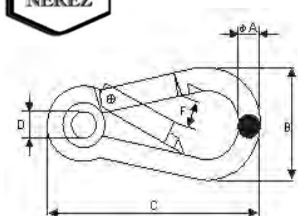

material: stainless steel AISI 316

Kód Art. No.	C mm	A mm	D mm	F mm	B mm	nosnost WLL kg	kg/100ks kg/100pcs	balení/ks bag/pcs	karton/ks carton/pcs
9435.005	50	5	7	8	25	90	1,6	20	200
9435.006	60	6	7	8	30	120	2,7	20	200
9435.008	80	8	10	11	40	250	6,6	10	100
9435.010	100	10	14	15	50	350	12,8	5	100

## Karabina hasičská s okem a pojistkou

norma: DIN 5299D

povrch: galvanický zinkochromát (bílý) > 8µm

materiál: ocel S235JR, pevn.tř.4.6, Re 235MPa

**Snap hook with eyelet and screw**

finish: galvanized > 8µm

material: carbon steel St37-2



Kód Art. No.	C mm	A mm	D mm	F mm	B mm	nosnost WLL kg	kg/100ks kg/100pcs	balení/ks bag/pcs	karton/ks carton/pcs
2435.S05	50	5	5	7	25	100	1,9	50	1 200
2435.S06	60	6	5	8	30	140	3,2	50	700
2435.S07	70	7	7	8	35	200	4,8	25	500
2435.S08	80	8	10	9	40	250	7,2	25	300
2435.S10	100	10	13	11	50	400	13,4	20	140
2435.S11	120	11	13	16	57	500	19,5	10	100
2435.S12	140	12	15	19	67	600	26,7	10	80

materiál: nerezavějící ocel A4

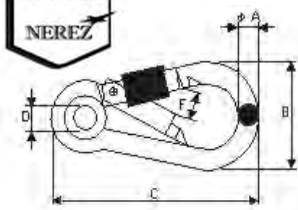

material: stainless steel AISI 316

Kód Art. No.	C mm	A mm	D mm	F mm	B mm	nosnost WLL kg	kg/100ks kg/100pcs	balení/ks bag/pcs	karton/ks carton/pcs
9435.S05	50	5	7	8	25	90	1,6	20	200
9435.S06	60	6	7	8	30	120	2,7	20	200
9435.S08	80	8	10	11	40	250	6,6	10	100
9435.S10	100	10	14	15	50	350	12,8	5	100

## Článek Rapid

**povrch:** galvanický zinkochromát (bílý) > 8µm  
**materiál:** ocel S235JR, pevn.tř.4.6, Re 235MPa

**Quick link**

**finish:** galvanized > 8µm  
**material:** carbon steel St37-2



Kód Art. No.	A mm	L1 mm	L2 mm	F mm	nosnost WLL kg	kg/100ks kg/100pcs	balení/ks bag/pcs	karton/ks carton/pcs
2537.003	3,5	36	17	5	100	0,9	100	2 500
2537.004	4	40	20	6	200	1,2	50	2 000
2537.005	5	49	23	7	300	2,1	50	1 000
2537.006	6	58	27	8	400	3,3	50	600
2537.007	7	66	30	8	550	5,1	25	400
2537.008	8	76	34	10	700	7,2	25	300
2537.009	9	82	36	11	900	9,6	20	250
2537.010	10	90	40	12	1100	13,2	20	200
2537.012	12	107	48	15	1500	21,4	10	100
2537.014	14	125	55	17	2200	37,7	5	60

**materiál:** nerezavějící ocel A4

**material:** stainless steel AISI 316

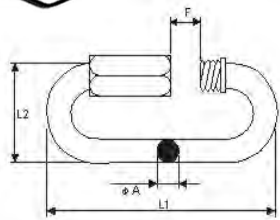

Kód Art. No.	A mm	L1 mm	L2 mm	F mm	nosnost WLL kg	kg/100ks kg/100pcs	balení/ks bag/pcs	karton/ks carton/pcs
9537.003	3,5	29	10	5	100	0,9	10	200
9537.004	4	32	12	6	200	1,2	10	200
9537.005	5	38	13	7	300	2,1	10	200
9537.006	6	45	14	8	400	3,3	10	200
9537.007	7	52	16	9	550	5,1	5	100
9537.008	8	60	18	10	700	7,2	5	100
9537.010	10	69	20	12	1100	13,2	5	100

## Článek Rapid - trojúhelníkový

**povrch:** galvanický zinkochromát (bílý) > 8µm  
**materiál:** ocel S235JR, pevn.tř.4.6, Re 235MPa

**Delta shaped quick link**

**finish:** galvanized > 8µm  
**material:** carbon steel St37-2

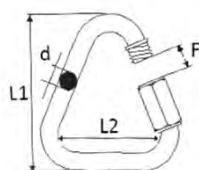

Kód Art. No.	d mm	L1 mm	L2 mm	F mm	nosnost WLL kg	kg/100ks kg/100pcs	balení/ks bag/pcs	karton/ks carton/pcs
2539.004	3,5	37	31	5	120	1,4	25	1 500
2539.005	5	47	40	6	450	2,3	25	800
2539.006	6	56	47	7,5	600	3,9	20	500
2539.008	8	73	56	10	1100	8,4	20	240
2539.010	10	87	66	12	1500	15,6	10	150

## Karabina hliníková

**povrch:** barevný

**materiál:** eloxovaný hliník

**barvy:** černá, modrá, zelená, červená, fialová, žlutá, stříbrná

## Aluminium Snap hook

**finish:** colours

**material:** eloxed aluminium

**colours:** black, blue, green, red, purple, yellow, silver

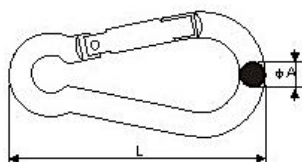

Kód Art. No.	L mm	A mm	barva colour	nosnost WLL kg	kg/100ks kg/100pcs	balení/ks bag/pcs	karton/ks carton/pcs
2436.05A	50	5	mix	10	0,55	70	2 100
2436.05C	50	5	černá	10	0,55	25	2 100
2436.05F	50	5	fialová	10	0,55	25	2 100
2436.05M	50	5	modrá	10	0,55	25	2 100
2436.05R	50	5	červená	10	0,55	25	2 100
2436.05S	50	5	stříbrná	10	0,55	25	2 100
2436.05Y	50	5	žlutá	10	0,55	25	2 100
2436.05Z	50	5	zelená	10	0,55	25	2 100
2436.06A	60	6	assorted	15	0,90	70	1 400
2436.06C	60	6	black	15	0,90	25	1 400
2436.06F	60	6	purple	15	0,90	25	1 400
2436.06M	60	6	blue	15	0,90	25	1 400
2436.06R	60	6	red	15	0,90	25	1 400
2436.06S	60	6	silver	15	0,90	25	1 400
2436.06Y	60	6	yellow	15	0,90	25	1 400
2436.06Z	60	6	green	15	0,90	25	1 400
2436.08A	80	8	mix	25	1,60	35	700

## Karabina hliníková s kroužkem

**povrch:** barevný mix

**materiál:** eloxovaný hliník

**barvy:** černá, modrá, zelená, červená, fialová, žlutá, stříbrná

## Aluminium Snap hook with key ring

**finish:** colours assorted

**material:** eloxed aluminium

**colours:** black, blue, green, red, purple, yellow, silver

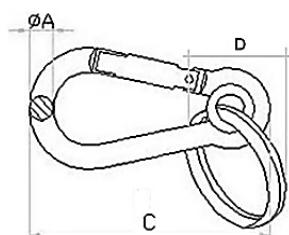

Kód Art. No.	C mm	A / D mm	barva colour	nosnost WLL kg	kg/100ks kg/100pcs	balení/ks bag/pcs	karton/ks carton/pcs
2437.05A	50	5/20	mix	10	0,55	35	2 100
2437.05C	50	5/20	černá	10	0,55	25	2 100
2437.05F	50	5/20	fialová	10	0,55	25	2 100
2437.05M	50	5/20	modrá	10	0,55	25	2 100
2437.05R	50	5/20	červená	10	0,55	25	2 100
2437.05S	50	5/20	stříbrná	10	0,55	25	2 100
2437.05Y	50	5/20	žlutá	10	0,55	25	2 100
2437.05Z	50	5/20	zelená	10	0,55	25	2 100
2437.06A	60	6/25	assorted	15	0,90	35	1 400
2437.06C	60	6/25	black	15	0,90	25	1 400
2437.06F	60	6/25	purple	15	0,90	25	1 400
2437.06M	60	6/25	blue	15	0,90	25	1 400
2437.06R	60	6/25	red	15	0,90	25	1 400
2437.06S	60	6/25	silver	15	0,90	25	1 400
2437.06Y	60	6/25	yellow	15	0,90	25	1 400
2437.06Z	60	6/25	green	15	0,90	25	1 400
2437.08A	80	8/30	mix	25	1,60	20	700

## Karabina hliníková typ "D"

**povrch:** barevný mix

**materiál:** eloxovaný hliník

**barvy:** černá, modrá, zelená, červená, fialová, žlutá, stříbrná

## Aluminium Snap hook "D" type

**finish:** colours assorted

**material:** eloxed aluminium

**colours:** black, blue, green, red, purple, yellow, silver

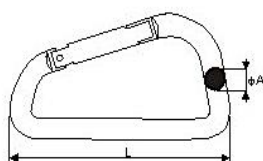

Kód Art. No.	L mm	A mm	barva colour	nosnost WLL kg	kg/100ks kg/100pcs	balení/ks bag/pcs	karton/ks carton/pcs
2438.05A	50	5	mix	10	0,55	70	2 100
2438.05C	50	5	černá	10	0,55	25	2 100
2438.05F	50	5	fialová	10	0,55	25	2 100
2438.05M	50	5	modrá	10	0,55	25	2 100
2438.05R	50	5	červená	10	0,55	25	2 100
2438.05S	50	5	stříbrná	10	0,55	25	2 100
2438.05Y	50	5	žlutá	10	0,55	25	2 100
2438.05Z	50	5	zelená	10	0,55	25	2 100
2438.06A	60	6	assorted	15	0,90	70	1 400
2438.06C	60	6	black	15	0,90	25	1 400
2438.06F	60	6	purple	15	0,90	25	1 400
2438.06M	60	6	blue	15	0,90	25	1 400
2438.06R	60	6	red	15	0,90	25	1 400
2438.06S	60	6	silver	15	0,90	25	1 400
2438.06Y	60	6	yellow	15	0,90	25	1 400
2438.06Z	60	6	green	15	0,90	25	1 400
2438.08A	80	8	mix	25	1,60	35	700

## Karabina hliníková typ "D" s pojistkou

**povrch:** barevný mix

**materiál:** eloxovaný hliník

**barvy:** černá, modrá, zelená, červená, fialová, žlutá, stříbrná

## Aluminium Snap hook "D" type with screw

**finish:** colours assorted

**material:** eloxed aluminium

**colours:** black, blue, green, red, purple, yellow, silver

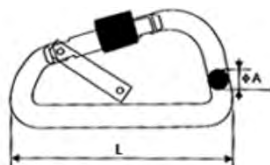

Kód Art. No.	L mm	A mm	barva colour	nosnost WLL kg	kg/100ks kg/100pcs	balení/ks bag/pcs	karton/ks carton/pcs
2439.05A	50	5	mix	10	1,10	50	2 100
2439.06A	60	6	assorted	15	1,60	50	1 400
2439.08A	80	8	mix	25	2,50	20	700

## Karabina otočná U1

**povrch:** poniklováno

**materiál:** zinková slitina Zamak2 (ZnAl4Cu3)

**Swivel snap U1**

**finish:** nickel plated

**material:** die cast, zinc alloy



Kód Art. No.	L mm	D mm	F mm	kg/100ks kg/100pcs	balení/ks bag/pcs	karton/ks carton/pcs
2407.U10	53	10	5	1,0	50	2 000
2407.U13	60	12	6	1,2	50	1 500
2407.U16	67	16	7	2,0	25	1 000

## Karabina otočná U2

**povrch:** poniklováno

**materiál:** zinková slitina Zamak2 (ZnAl4Cu3)

**Swivel snap U2**

**finish:** nickel plated

**material:** die cast, zinc alloy



Kód Art. No.	L mm	D mm	F mm	kg/100ks kg/100pcs	balení/ks bag/pcs	karton/ks carton/pcs
2408.U13	70	13	9	2,5	25	800
2408.U16	80	16	10	2,9	25	800
2408.U20	80	20	11	3,5	20	500
2408.U26	90	26	11	4,5	20	500

## Karabina otočná popruhová D

**povrch:** poniklováno

**materiál:** zinková slitina Zamak2 (ZnAl4Cu3)

**Swivel strap snaps D**

**finish:** nickel plated

**material:** die cast, zinc alloy



Kód Art. No.	L mm	D mm	F mm	kg/100ks kg/100pcs	balení/ks bag/pcs	karton/ks carton/pcs
2408.D20	80	20	11	4,0	20	2 100
2408.D26	80	26	12	4,2	20	1 400

## Karabina oboustranná

**povrch:** poniklováno

**materiál:** zinková slitina Zamak2 (ZnAl4Cu3)

**Double snap**

**finish:** nickel plated

**material:** die cast, zinc alloy



Kód Art. No.	B mm	A mm	C mm	kg/100ks kg/100pcs	balení/ks bag/pcs	karton/ks carton/pcs
2411.090	90	11	25	3,6	20	500

## Karabina vypouštěcí

**povrch:** poniklováno

**materiál:** zinková slitina Zamak2 (ZnAl4Cu3)

**Trigger snap**

**finish:** nickel plated

**material:** die cast, zinc alloy



Kód Art. No.	L mm	D mm	F mm	kg/100ks kg/100pcs	balení/ks bag/pcs	karton/ks carton/pcs
2413.U10	60	10	10	3,20	20	500
2413.U13	65	13	10	3,60	20	500
2413.U20	70	20	10	4,10	20	500

## Karabina vypouštěcí "Panik"

**povrch:** poniklováno

**materiál:** zinková slitina Zamak2 (ZnAl4Cu3)

**Panic snap**

**finish:** nickel plated

**material:** die cast, zinc alloy



Kód Art. No.	délka mm	oko mm	typ	kg/100ks kg/100pcs	balení/ks bag/pcs	karton/ks carton/pcs
2414.D26	105	26	otočné	13,4	5	150
2414.P13	102	13	pevné	12,0	5	150
2414.U26	120	26	otočné	13,7	5	150

## Obrtlík na vodítka

**povrch:** poniklováno

**materiál:** zinková slitina Zamak2 (ZnAl4Cu3)

**Swivel**

**finish:** nickel plated

**material:** die cast, zinc alloy



Kód Art. No.	A mm	B mm	kg/100ks kg/100pcs	balení/ks bag/pcs	karton/ks carton/pcs
2426.U13	13	50	2,1	20	1 000
2426.U16	16	62	3,4	20	500
2426.U20	20	70	4,0	20	500
2426.U22	22	72	4,3	20	500
2426.U26	26	76	4,4	20	500

## Otočný čep na řetěz

**povrch:** poniklováno

**materiál:** slitina zinku a mědi

**Chain swivel**

**finish:** nickel plated

**material:** die cast



Kód Art. No.	A mm	B mm	C mm	kg/100ks kg/100pcs	balení/ks bag/pcs	karton/ks carton/pcs
2427.60	60	16	10	5,5	20	500
2427.70	70	19	11	7,5	20	300
2427.80	80	22	12	10,8	10	200







# Ocelová lana

---

*Wire ropes*

## Lano ocelové jednopramenné (1x19)

**povrch:** galvanický zinkochromát > 8µm  
**materiál:** vysokouhlíková ocel, pevn. 1770MPa  
**konstrukce:** pravé vinutí 1 x 19 (1+6+12)  
**norma:** DIN 3053 / EN 12385-4

**Wire rope single strand**

**finish:** zinc galvanized > 8µm  
**material:** high carbon steel  
**construction:** right stranding 1 x 19 (1+6+12)  
**norm:** DIN 3053

3



Kód Art. No.	lano Ø rope Ø mm	Minimální pevnost v tahu (kN) Minimum breaking strenght (kN)		Nosnost WLL Kg	Váha Weight Kg / 100m	Volitelný Optional min. m	Cívka Reel m	Cívka Reel m
		*1570N /mm <sup>2</sup>	1770N /mm <sup>2</sup>					
3491.010	1,00	0,825	0,930	25	0,50	100	400	2 000
3491.012	1,25	1,190	1,340	35	0,71	100	400	2 000
3491.016	1,60	1,860	2,090	60	1,11	100	400	2 000
3491.020	2,00	3,300	3,720	100	1,98	50	200	2 000
3491.025	2,50	5,150	5,810	150	3,10	50	200	1 000
3491.030	3,15	7,420	8,370	210	4,46	25	100	1 000

**materiál:** nerezavějící ocel A4, 1570N /mm<sup>2</sup>  
**konstrukce:** pravé vinutí 1 x 19 (1+6+12)

**material:** stainless steel AISI 316  
**construction:** right stranding 1 x 19



Kód Art. No.	lano Ø rope Ø mm	Minimální pevnost v tahu (kN) Minimum breaking strenght (kN)		Nosnost WLL Kg	Váha Weight Kg / 100m	Volitelný Optional min. m	Cívka Reel m	Cívka Reel m
		1570N /mm <sup>2</sup>	1770N /mm <sup>2</sup>					
9491.006	0,60	0,308	---	9	0,18	100	250	2 000
9491.010	1,00	0,825	---	25	0,50	50	200	2 000
9491.012	1,25	1,190	---	35	0,71	50	200	2 000
9491.015	1,50	1,860	---	50	1,11	50	100	2 000
9491.020	2,00	3,300	---	100	1,98	50	100	2 000

## Lano ocelové šestipramenné (6x37+FC)

**povrch:** galvanický zinkochromát > 8µm  
**materiál:** vysokouhlíková ocel, pevn. 1770MPa  
**konstrukce:** pravé křížové vinutí 6 x 37 +FC (1+6+12+18)  
**norma:** DIN 3066 / EN 12385-4

**Wire rope six strand**

**finish:** zinc galvanized > 8µm  
**material:** high carbon steel  
**construction:** right stranding 6 x 37 + FC  
**norm:** DIN 3066



Kód Art. No.	lano Ø rope Ø mm	Minimální pevnost v tahu (kN) Minimum breaking strenght (kN)		Nosnost WLL Kg	Váha Weight Kg / 100m	Volitelný Optional min. m	Cívka Reel m	Cívka Reel m
		1770N /mm <sup>2</sup>	*1960N /mm <sup>2</sup>					
3499.080	8,0	29,60	37,00	1000	22,0	25	50	1 000
3499.105	10,5	46,30	57,80	1600	32,0	10	50	1 000
3499.125	12,5	66,60	83,20	2500	50,0	10	50	500
3499.140	14,0	90,70	97,70	3200	64,0	-	-	500
3499.160	16,0	102,00	112,90	4000	81,0	-	-	250
3499.180	18,0	197,50	148,40	5000	103,0	-	-	250
3499.200	20,0	249,90	187,10	6400	130,0	-	-	200
3499.220	22,4	308,70	---	7900	160,0	-	-	200
3499.250	25,0	387,10	---	10000	201,0	-	-	200
3499.280	28,0	482,10	---	12300	251,0	-	-	200
3499.300	30,0	537,70	---	13700	280,0	-	-	200

## Lano ocelové šestipramenné (6x7+FC)

**povrch:** galvanický zinkochromát > 8µm  
**materiál:** vysokouhlíková ocel, pevn. 1770MPa  
**konstrukce:** pravé křížové vinutí 6 x 7 + FC (1+6)  
**norma:** DIN 3055 / EN 12385-4

**Wire rope six strand**

**finish:** zinc galvanized > 8µm  
**material:** high carbon steel

**construction:** right cross strand. 6 x 7 + FC  
**norm:** DIN 3055



Kód Art. No.	lano Ø rope Ø mm	Minimální pevnost v tahu (kN) Minimum breaking strenght (kN)		Nosnost WLL Kg	Váha Weight Kg / 100m	Volitelný Optional min. m	Cívka Reel m	Cívka Reel m
		1770N /mm <sup>2</sup>	*1960N /mm <sup>2</sup>					
3494.020	2,0	2,350	2,600	60	1,30	50	200	2 000
3494.025	2,5	3,670	4,060	100	2,20	50	200	2 000
3494.030	3,2	5,290	5,860	150	3,20	25	100	1 000
3494.040	4,0	9,410	10,400	240	5,40	25	100	1 000
3494.050	5,0	14,700	16,300	380	8,00	25	100	1 000
3494.060	6,3	21,100	23,400	590	11,80	25	100	1 000
3494.080	8,0	37,600	41,600	950	21,20	10	50	500
3494.105	10,5	58,800	---	1500	31,50	10	50	500

**provedení:** (6x7+FC) v PVC

**Wire rope PVC coated**



Kód Art. No.	lano Ø rope Ø mm	Minimální pevnost v tahu (kN) Minimum breaking strenght (kN)		Nosnost WLL Kg	Váha Weight Kg / 100m	Volitelný Optional min. m	Cívka Reel m	Cívka Reel m
		1770N /mm <sup>2</sup>	*1960N /mm <sup>2</sup>					
3495.012	1,2/2	0,850	0,940	20	0,6	50	200	2 000
3495.023	2/3	2,350	2,600	60	2,0	50	100	2 000
3495.034	3/4	5,290	5,860	150	4,0	25	100	1 000
3495.045	4/5	9,410	10,400	240	6,5	25	100	750
3495.056	5/6	14,700	16,300	380	10,5	25	100	500
3495.068	6/8	21,100	23,400	590	16,0	10	50	250

**konstrukce:** pravé křížové vinutí 6x7+IWRC (7x7)

**onstruction:** right cross strand. 6x7+IWRC



Kód Art. No.	lano Ø rope Ø mm	Minimální pevnost v tahu (kN) Minimum breaking strenght (kN)		Nosnost WLL Kg	Váha Weight Kg / 100m	Volitelný Optional min. m	Cívka Reel m	Cívka Reel m
		1770N /mm <sup>2</sup>	*1960N /mm <sup>2</sup>					
3496.040	4,0	10,200	11,300	240	6,29	50	100	1 000
3496.050	5,0	15,900	17,600	380	9,83	50	100	500
3496.060	6,3	22,900	25,400	590	14,20	25	100	500
3496.080	8,0	40,600	45,000	950	25,20	25	50	500
3496.105	10,5	63,500	---	1500	39,30	20	50	250

**materiál:** nerezavějící ocel A4, 1570N /mm<sup>2</sup>

**konstrukce:** pravé křížové vinutí s drátěnou duší 6 x 7 + WSC (7x7)

**material:** stainless steel AISI 316

**construction:** right cross stranding with wire core 6 x 7 + IWRC (7x7)



Kód Art. No.	lano Ø rope Ø mm	Minimální pevnost v tahu (kN) Minimum breaking strenght (kN)		Nosnost WLL Kg	Váha Weight Kg / 100m	Volitelný Optional min. m	Cívka Reel m	Cívka Reel m
		1570N /mm <sup>2</sup>	*1770N /mm <sup>2</sup>					
9497.010	1,0	0,560	0,670	20	0,40	50	200	2 000
9497.012	1,2	0,835	0,910	30	0,57	50	200	2 000
9497.015	1,5	1,270	1,430	40	0,88	50	200	2 000
9497.020	2,0	2,260	2,540	70	1,57	50	100	2 000
9497.025	2,5	3,520	3,970	100	2,46	50	100	1 000
9497.030	3,0	5,050	5,710	150	3,54	50	100	1 000
9497.040	4,0	8,980	10,200	270	6,29	25	100	1 000
9497.050	5,0	14,000	15,900	430	9,83	25	100	500
9497.060	6,0	20,300	22,900	600	14,20	25	50	500
9497.080	8,0	36,100	40,600	800	25,20	10	50	500
9497.105	10,5	56,300	63,500	1050	39,30	5	25	500

## Lano ocelové šestipramenné (6x19+FC)

**Wire rope six strand**

**povrch:** galvanický zinkochromát > 8µm

**materiál:** vysokouhlíková ocel, pevn. 1770MPa

**konstrukce:** pravé křížové vinutí 6 x 19 +FC (1+6+12)

**norma:** DIN 3060 / EN 12385-4

**finish:** zinc galvanized > 8µm

**material:** high carbon steel

**construction:** right stranding 6 x 19 + FC

**norm:** DIN 3060

3



Kód Art. No.	lano Ø rope Ø mm	Minimální pevnost v tahu (kN) Minimum breaking strength (kN)		Nosnost WLL Kg	Váha Weight Kg / 100m	Volitelný Optional min. m	Cívka Reel m	Cívka Reel m
		1770N /mm <sup>2</sup>	*1960N /mm <sup>2</sup>					
3497.030	3,0	4,900	5,430	150	3,1	50	100	1 000
3497.040	4,0	8,700	9,630	260	5,2	50	100	1 000
3497.050	5,0	13,600	15,100	400	8,2	50	100	1 000
3497.060	6,3	19,600	21,700	650	13,0	25	100	1 000
3497.080	8,0	34,800	38,500	1000	21,5	25	50	1 000
3497.105	10,5	54,400	60,200	1600	33,0	20	50	500
3497.125	12,5	78,300	86,740	2600	53,0	10	50	500

**konstrukce:** pravé křížové vinutí 6x19+IWRC

**construction:** right stranding 6x19+IWRC



Kód Art. No.	lano Ø rope Ø mm	Minimální pevnost v tahu (kN) Minimum breaking strength (kN)		Nosnost WLL Kg	Váha Weight Kg / 100m	Volitelný Optional min. m	Cívka Reel m	Cívka Reel m
		1770N /mm <sup>2</sup>	*1960N /mm <sup>2</sup>					
3498.040	4,0	9,40	10,40	260	5,2	50	100	1 000
3498.050	5,0	14,70	16,30	400	8,2	50	100	1 000
3498.060	6,3	21,20	23,50	650	13,0	25	100	1 000
3498.080	8,0	37,60	41,60	1000	21,5	25	50	1 000
3498.105	10,5	58,80	65,10	1600	33,0	20	50	500
3498.125	12,5	84,60	93,70	2600	53,0	10	50	500

**materiál:** nerezavějící ocel A4, 1570N /mm<sup>2</sup>

**konstrukce:** pravé křížové vinutí s drátěnou duší 6x19+IWRC (7x19)

**material:** stainless steel AISI 316

**construction:** right cross stranding with wire core 6 x 19 + WSC (7x19)



Kód Art. No.	lano Ø rope Ø mm	Minimální pevnost v tahu (kN) Minimum breaking strength (kN)		Nosnost WLL Kg	Váha Weight Kg / 100m	Volitelný Optional min. m	Cívka Reel m	Cívka Reel m
		1570N /mm <sup>2</sup>	*1770N /mm <sup>2</sup>					
9498.060	6,0	18,300	21,200	700	14,5	100	100	500
9498.080	8,0	33,300	37,600	1200	25,5	50	50	500
9498.105	10,5	52,100	58,800	1900	39,0	25	25	500
9498.125	12,5	75,000	84,600	2800	55,0	25	25	250

## Ostatní konstrukce ocelových lan na objednávku

**The other construction of Wire ropes upon order**

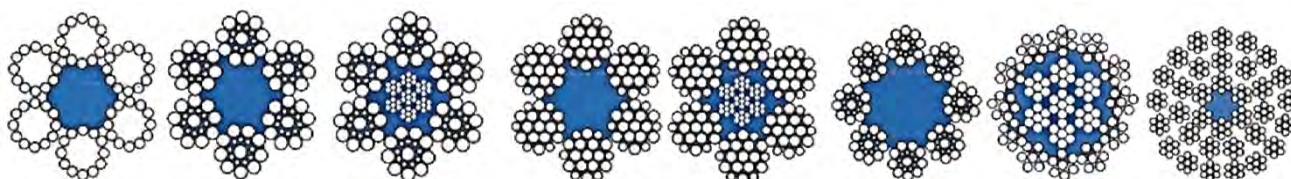

6x12+7FC    6x19S+FC    6x19S+IWRC    6x19W+FC    6x19W+IWRC    8x19S+FC    18x7+IWSC    37x7+FC



# Příslušenství k ocelovým lanům

*Wire ropes accessories*

## Svorka lanová DIN 741

**povrch:** galvanický zinkochromát (bílý) > 8µm  
**materiál:** třmen - ocel S235JR, pevn.tř.4.6, Re 235MPa  
 patka - tvárná litina GGG 35.3

### Wire rope clip DIN 741

**finish:** galvanized > 8µm  
**material:** u-bolt - steel St37-2  
 body - malleable iron



Kód Art. No.	lano Ø rope	závit thread	B mm	C mm	D mm	F mm	kg/100ks kg/100pcs	balení/ks bag/pcs	karton/ks carton/pcs
3426.03	3	M4	20	9	12	21	0,85	100	2 500
3426.05	5	M5	24	11	13	23	1,30	100	2 000
3426.06	6,5	M5	28	13	15	26	1,65	100	1 600
3426.08	8	M6	34	16	19	30	2,70	50	800
3426.10	10	M8	42	19	22	34	5,70	50	400
3426.11	11	M8	44	20	22	36	6,00	25	400
3426.13	13	M10	55	24	30	42	10,80	20	200
3426.14	14	M10	57	25	30	44	11,00	20	200
3426.16	16	M12	63	29	33	50	17,80	10	125
3426.19	19	M12	75	32	38	54	22,40	10	100
3426.22	22	M14	85	37	44	61	34,90	5	50
3426.26	26	M14	95	41	45	65	40,30	5	50
3426.30	30	M16	110	48	50	74	60,30	1	30
3426.34	34	M16	120	52	55	80	73,60	1	25
3426.40	40	M16	140	58	60	88	92,50	1	20

**materiál:** nerezavějící ocel A4



**material:** stainless steel AISI 316

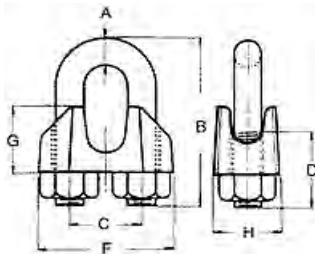

Kód Art. No.	lano Ø rope	závit thread	B mm	C mm	D mm	F mm	kg/100ks kg/100pcs	balení/ks bag/pcs	karton/ks carton/pcs
9426.02	2	M3	18	8	10	17	0,70	20	1 000
9426.03	3	M3	20	9	12	21	1,15	20	1 000
9426.04	4	M4	22	10	13	22	1,50	20	1 000
9426.05	5	M5	24	11	13	23	1,70	20	800
9426.06	6,5	M6	28	13	15	26	2,10	10	500
9426.08	8	M6	34	16	19	30	3,40	10	300
9426.10	10	M8	42	19	22	34	6,20	5	200
9426.13	13	M10	55	24	30	42	12,60	1	100
9426.16	16	M12	42	19	22	34	19,80	1	50

## Svorka lanová, plochá

**povrch:** galvanický zinkochromát (bílý) > 8µm  
**materiál:** tvárná litina GGG 40, DIN 1692

### Oval wire rope clip

**finish:** galvanized > 8µm  
**material:** malleable iron

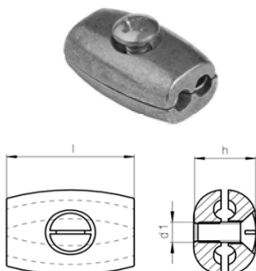

Kód Art. No.	lano Ø rope	l mm	h mm	d1 mm	kg/100ks kg/100pcs	balení/ks bag/pcs	karton/ks carton/pcs
3427.02	2	28	11	M5	1,60	50	1 250
3427.03	3	28	12	M5	1,60	50	1 000
3427.04	4	34	14	M6	3,60	25	500
3427.05	5	34	15	M6	4,00	25	500
3427.06	6	35	15	M6	4,50	25	400

## Svorka lanová Simplex

**povrch:** galvanický zinkochromát (bílý) > 8µm  
**materiál:** ocel S235JR, pevn.tř.4.6, Re 235MPa

### Simplex wire rope clip

**finish:** galvanized > 8µm  
**material:** carbon steel St 37-2



Kód Art. No.	lano Ø rope	L mm	D mm	kg/100ks kg/100pcs	balení/ks bag/pcs	karton/ks carton/pcs
3428.02	2	15	M4	0,50	100	5 000
3428.03	3	17	M4	0,70	100	3 000
3428.04	4	20	M5	1,10	50	2 000
3428.05	5	25	M5	1,50	50	1 500
3428.06	6	30	M6	2,20	50	1 000
3428.08	8	37	M8	4,80	20	400
3428.10	10	42	M10	9,20	10	200

**materiál:** nerezavějící ocel A4

**material:** stainless steel AISI 316

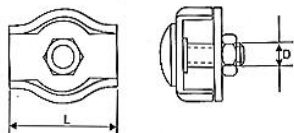

Kód Art. No.	lano Ø rope	L mm	D mm	kg/100ks kg/100pcs	balení/ks bag/pcs	karton/ks carton/pcs
9428.02	2	15	M4	0,40	20	1 000
9428.03	3	17	M4	0,60	20	1 000
9428.04	4	20	M5	1,00	20	500
9428.05	5	25	M5	1,40	20	500
9428.06	6	30	M6	2,10	10	300
9428.08	8	37	M8	4,50	5	200

## Svorka lanová Duplex

**povrch:** galvanický zinkochromát (bílý) > 8µm  
**materiál:** ocel S235JR, pevn.tř.4.6, Re 235MPa

### Duplex wire rope clip

**finish:** galvanized > 8µm  
**material:** carbon steel St 37-2



Kód Art. No.	lano Ø rope	L mm	D mm	kg/100ks kg/100pcs	balení/ks bag/pcs	karton/ks carton/pcs
3429.02	2	30	M4	1,00	50	2 500
3429.03	3	35	M4	1,35	50	2 000
3429.04	4	40	M5	2,30	50	1 000
3429.05	5	50	M5	3,10	25	700
3429.06	6	60	M6	4,60	25	400
3429.08	8	75	M8	9,80	10	200
3429.10	10	84	M10	18,90	5	100

**materiál:** nerezavějící ocel A4

**material:** stainless steel AISI 316

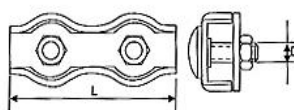

Kód Art. No.	lano Ø rope	L mm	D mm	kg/100ks kg/100pcs	balení/ks bag/pcs	karton/ks carton/pcs
9429.02	2	30	M4	0,90	10	1 000
9429.03	3	35	M4	1,20	10	1 000
9429.04	4	40	M5	2,10	10	500
9429.05	5	50	M5	2,80	5	500
9429.06	6	60	M6	4,50	5	300
9429.08	8	75	M8	9,20	2	200

## Objímka lisovací DIN 3093

materiál: slitina hliníku

**Ferrule DIN 3093**

material: aluminium

4

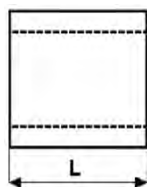
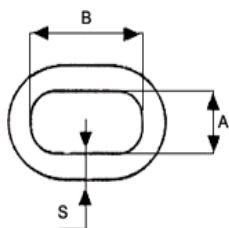

Kód Art. No.	lano Ø rope	A mm	B mm	S mm	L mm	kg/100ks kg/100pcs	balení/ks bag/pcs	karton/ks carton/pcs
3430.010	1,0	1,2	2,4	0,65	5	0,010	200	10 000
3430.015	1,5	1,7	3,4	0,75	6	0,018	200	10 000
3430.020	2,0	2,2	4,4	0,85	7	0,025	200	10 000
3430.025	2,5	2,7	5,4	1,05	9	0,045	200	5 000
3430.030	3,0	3,3	6,6	1,25	11	0,080	200	2 500
3430.035	3,5	3,8	7,6	1,50	13	0,120	100	2 000
3430.040	4,0	4,4	8,8	1,70	14	0,180	100	1 250
3430.045	4,5	4,9	9,8	1,90	16	0,260	100	1 000
3430.050	5,0	5,5	11,0	2,10	18	0,360	100	1 000
3430.060	6,0	6,6	13,2	2,50	21	0,590	50	1 000
3430.065	6,5	7,2	14,4	2,70	23	0,760	50	1 000
3430.070	7,0	7,8	15,6	2,90	25	0,950	50	1 000
3430.080	8,0	8,8	17,6	3,30	28	1,370	50	1 000
3430.090	9,0	9,9	19,8	3,70	32	1,980	50	1 000
3430.100	10,0	10,9	21,8	4,10	35	2,640	25	500
3430.120	12,0	13,2	26,4	4,90	42	4,580	25	250
3430.130	13,0	14,2	28,4	5,40	46	5,970	25	200
3430.140	14,0	15,3	30,6	5,80	49	7,350	25	200
3430.160	16,0	17,5	35,0	6,70	56	11,100	20	200
3430.180	18,0	19,6	39,2	7,60	63	15,900	15	100
3430.200	20,0	21,7	43,4	8,40	70	21,700	10	100
3430.220	22,0	24,3	48,6	9,20	77	29,200	5	50
3430.240	24,0	26,4	52,8	10,00	84	37,600	5	50
3430.260	26,0	28,5	57,0	10,90	91	48,100	1	25
3430.280	28,0	31,0	62,0	11,70	98	60,300	1	25
3430.300	30,0	33,0	66,2	12,60	105	73,500	1	25
3430.320	32,0	35,2	70,4	13,40	112	89,700	1	25
3430.340	34,0	37,8	75,6	14,20	119	108,200	1	20
3430.360	36,0	39,8	79,6	15,00	126	127,500	1	15
3430.380	38,0	41,9	83,8	15,80	133	150,300	1	15
3430.400	40,0	44,0	88,0	16,60	140	173,400	1	10

- na objednávku i z mědi a nerez. oceli, dodání 3-4 měsíce od objednání

- available in copper and st. steel to order only, delivery time 3-4 months from ordering

## Objímka lisovací koncová

materiál: slitina hliníku

**Stop button ferrule**

material: aluminium

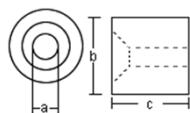

Kód Art. No.	lano Ø rope	a mm	b mm	c mm	kg/100ks kg/100pcs	balení/ks bag/pcs	karton/ks carton/pcs
3432.016	1,6	1,9	6,4	4,2	0,030	100	4 000
3432.020	2,0	2,4	6,4	4,2	0,030	100	3 000
3432.025	2,5	2,9	8,7	8,0	0,110	100	2 500
3432.032	3,2	3,9	8,7	8,0	0,090	100	2 000
3432.040	4,0	4,7	11,1	8,7	0,180	100	1 500
3432.050	5,0	5,5	11,1	8,7	0,170	100	1 000
3432.063	6,3	7,2	17,5	17,5	0,910	50	500
3432.080	8,0	8,9	17,5	17,5	0,750	50	500
3432.100	10,5	11,2	20,2	20,2	1,080	50	500



## Svorka lanová DIN 1142

**povrch:** galvanický zinkochromát (žlutý) > 8µm  
**materiál:** třmen - ocel S355JR, pevn.tř.5.6, Re 300MPa  
 patka - tvárná litina GGG 40, DIN 1692

### Vire rope clip DIN 1142

**finish:** galvanized > 8µm  
**material:** u-bolt - steel St52-3  
 body - malleable iron

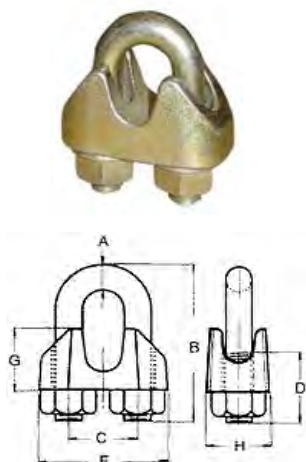

Kód Art. No.	Ø rope	závit thread	B mm	C mm	D mm	F mm	kg/100ks kg/100pcs	balení/ks bag/pcs	karton/ks carton/pcs
3442.05	5	M5	25	12	14	25	2,00	100	1 000
3442.06	6,5	M6	32	14	17	30	4,00	50	500
3442.08	8	M8	41	18	20	39	8,20	50	500
3442.10	10	M8	46	20	24	40	9,20	25	250
3442.13	13	M12	64	29	29	55	26,00	20	100
3442.16	16	M14	76	34	35	64	43,00	10	50
3442.19	19	M14	83	37	36	68	48,00	10	50
3442.22	22	M16	96	41	40	74	69,00	5	30
3442.26	26	M20	111	46	50	84	117,00	1	20
3442.30	30	M20	127	54	55	95	140,00	1	20
3442.34	34	M22	141	60	60	105	213,00	1	10
3442.40	40	M24	159	68	65	117	268,00	1	10

## Očnice DIN 65457 (DIN 6899A)

**povrch:** galvanický zinkochromát (bílý) > 8µm  
**materiál:** ocel S235JR, pevn.tř.4.6, Re 235MPa

### Thimble DIN 65457

**finish:** galvanized > 8µm  
**material:** carbon steel St 37-2

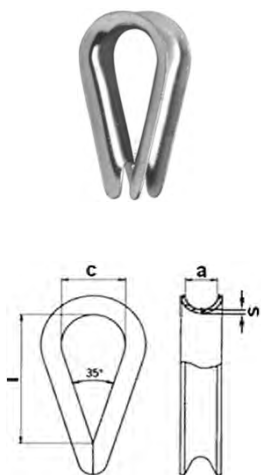

Kód Art. No.	lano Ø rope	a mm	l mm	c mm	s mm	kg/100ks kg/100pcs	balení/ks bag/pcs	karton/ks carton/pcs
3457.03	3	3,5	24	11	0,75	0,33	100	5 000
3457.04	4	5	29	13	0,75	0,55	100	3 000
3457.05	5	6	30	14	0,75	0,70	100	2 500
3457.06	6	7	33	15	0,75	0,90	100	1 500
3457.07	7	8	35	16	1,00	1,40	50	1 000
3457.08	8	9	39	18	1,00	1,90	50	1 000
3457.09	9	10	43	20	1,25	2,50	50	500
3457.10	10	11	48	22	1,25	2,90	25	500
3457.11	11	12	52	24	1,25	3,50	25	400
3457.12	12	13	57	26	1,50	4,70	20	400
3457.13	13	14	61	28	2,00	7,10	20	250
3457.14	14	15	70	32	2,50	10,40	20	150
3457.16	16	18	78	35	3,00	14,60	10	100
3457.18	18	20	86	40	3,50	20,00	10	100
3457.20	20	22	95	44	4,00	27,00	10	80

## Kleště lisovací kombi

**povrch:** leštěný, lakovaný  
**materiál:** čelisti - kal. legovaná ocel, pevn.tř.12.9, Re 1200MPa  
 ramena - kovaná ocel, pevn.tř.5.8, Re 350MPa

### Rope clamp swager

**finish:** polished, painted  
**material:** jaws - alloy steel  
 handles - forged steel



Kód Art. No.	lano Ø rope	délka mm	délka inch	střih max. Ø max. cut Ø	kg/1ks kg/1pcs	balení/ks bag/pcs	karton/ks carton/pcs
3550.18	1 - 5	460	18	5 mm	2,45	1	10
3550.24	2 - 6	610	24	6 mm	2,85	1	6

## Očnice DIN 6899B

**povrch:** galvanický zinkochromát (bílý) > 8µm  
**materiál:** ocel S235JR, pevn.tř.4.6, Re 235MPa

## Thimble DIN 6899B

**finish:** galvanized > 8µm  
**material:** carbon steel St 37-2



Kód Art. No.	lano Ø rope	a mm	l mm	c mm	s mm	kg/100ks kg/100pcs	balení/ks bag/pcs	karton/ks carton/pcs
3459.03	3	4	19	12	1,0	0,50	100	5 000
3459.04	4	5	21	13	1,0	0,70	100	3 000
3459.05	5	6	23	14	1,0	0,90	100	2 500
3459.06	6	7	25	16	1,3	1,40	100	1 500
3459.07	7	8	28	18	1,3	1,90	50	1 000
3459.08	8	9	32	20	1,5	2,60	50	1 000
3459.10	10	11	38	24	1,5	3,50	25	500
3459.12	12	13	48	30	2,0	6,20	20	400
3459.14	14	15	51	32	2,0	8,80	20	200
3459.16	16	17	58	36	2,5	12,80	10	140
3459.18	18	19	64	40	2,5	18,00	5	100
3459.20	20	21	72	45	3,0	25,00	5	80
3459.24	24	26	90	56	4,0	43,00	1	50
3459.26	26	28	99	62	5,0	57,00	1	40
3459.28	28	30	112	70	5,0	66,00	1	30
3459.30	30	32	120	75	6,0	85,00	1	20
3459.32	32	34	128	80	6,0	95,00	1	20
3459.34	34	36	152	95	6,0	107,00	1	15
3459.36	36	38	160	100	8,0	144,00	1	15
3459.38	38	40	176	110	8,0	164,00	1	10
3459.40	40	43	184	115	10,0	267,00	1	10
3459.42	42	45	192	120	10,0	305,00	1	5

**materiál:** nerezavějící ocel A4

**material:** stainless steel AISI 316

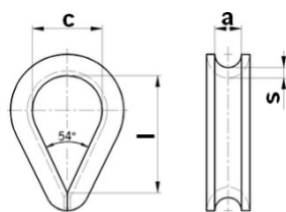

Kód Art. No.	lano Ø rope	a mm	l mm	c mm	s mm	kg/100ks kg/100pcs	balení/ks bag/pcs	karton/ks carton/pcs
9459.02	2	2,2	15	8	1,0	0,10	50	1 000
9459.03	3	3,2	16	10	1,0	0,20	50	1 000
9459.04	4	4,2	18	11	1,1	0,30	50	1 000
9459.05	5	5,5	21	13	1,1	0,50	50	1 000
9459.06	6	6,5	26	16	1,3	0,80	50	500
9459.08	8	8,5	33	18	1,6	1,60	25	500
9459.10	10	11,0	38	26	1,8	3,00	20	300
9459.12	12	13,0	48	30	2,0	5,00	10	200
9459.14	14	15,0	51	32	2,4	7,50	5	200
9459.16	16	17,0	58	36	2,6	10,50	1	100

## Kleště stříhací na lana

**povrch:** leštěný, lakovaný  
**materiál:** čelisti - kal. legovaná ocel, pevn.tř.12.9, Re 1200MPa  
 ramena - kovaná ocel, pevn.tř.5.8, Re 350MPa

## Wire rope cutter

**finish:** polished, painted  
**material:** jaws - alloy steel  
 handles - forged steel



Kód Art. No.	délka mm	délka inch	stříh max. Ø max. cut Ø	kg/1ks kg/1pcs	balení/ks bag/pcs	karton/ks carton/pcs
3551.24	610	24	12	2,05	1	10
3551.36	900	36	18	4,10	1	5
3551.42	1070	42	24	5,20	1	4



# Napínáky

---

*Turnbuckles*

## Napínák DIN 1480 oko-hák

**povrch:** galvanický zinkochromát (bílý) > 8µm  
**materiál:** kovaná ocel S235JR, tř.4.6, Re 235MPa

### Turnbuckle DIN 1480 eye-hook

**finish:** galvanized > 8µm  
**material:** forged steel St37-2

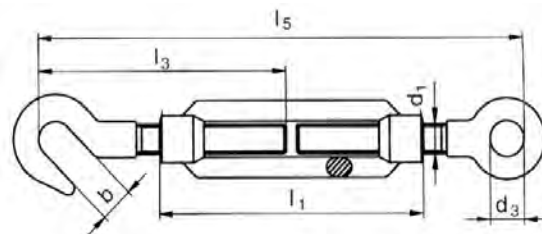

5

Kód Art. No.	závit thread	l1 mm	l2 mm	l5 mm	b mm	d3 mm	nosnost WLL kg	kg/100ks kg/100pcs	balení/ks bag/pcs	karton/ks carton/pcs
4480.A05	M5	70	50	105	8	9	60	4,7	25	500
4480.A06	M6	110	85	143	9	10	80	8,8	25	250
4480.A08	M8	110	80	157	10	12	120	14,0	15	150
4480.A10	M10	125	90	184	15	15	180	25,3	10	100
4480.A12	M12	125	85	222	16	17	260	39,1	10	50
4480.A14	M14	140	90	240	16	17	360	57,7	5	50
4480.A16	M16	170	115	272	21	23	500	86,3	5	30
4480.A20	M20	200	135	307	21	27	800	152,0	1	20
4480.A22	M22	220	145	340	23	27	1000	218,0	1	15
4480.A24	M24	255	175	390	26	30	1200	266,0	1	10
4480.A30	M30	255	165	430	30	30	1800	405,0	1	5
4480.A36	M36	295	185	480	35	35	2600	720,0	1	4

**materiál:** nerezavějící ocel A4

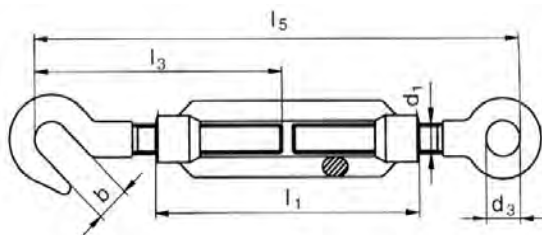

**material:** stainless steel AISI 316

Kód Art. No.	závit thread	l1 mm	l2 mm	l5 mm	b mm	d3 mm	nosnost WLL kg	kg/100ks kg/100pcs	balení/ks bag/pcs	karton/ks carton/pcs
9480.A05	M5	90	72	125	8	9	60	4,7	10	200
9480.A06	M6	110	88	140	9	10	80	8,8	10	100
9480.A08	M8	110	85	155	10	12	120	14,0	10	100
9480.A10	M10	125	93	180	15	15	180	25,3	5	50
9480.A12	M12	125	88	215	16	17	260	39,1	1	25
9480.A16	M16	170	120	260	21	23	500	57,7	1	20
9480.A20	M20	200	135	307	23	27	800	86,3	1	10

## Napínák DIN 1480 oko-oko

**povrch:** galvanický zinkochromát (bílý) > 8µm  
**materiál:** kovaná ocel S235JR, tř.4.6, Re 235MPa



## Turnbuckle DIN 1480 eye-eye

**finish:** galvanized > 8µm  
**material:** forged steel St37-2

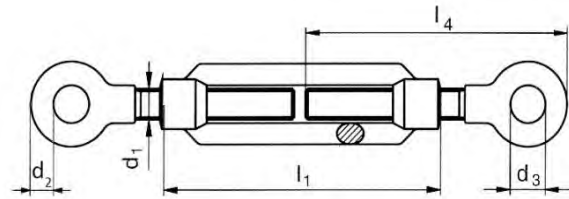

Kód Art. No.	závit thread	l1 mm	l2 mm	l4 mm	d3 mm	d2 mm	nosnost WLL kg	kg/100ks kg/100pcs	balení/ks bag/pcs	karton/ks carton/pcs
4480.B05	M5	70	50	50	9	4,0	80	4,4	25	500
4480.B06	M6	110	85	70	10	4,5	100	8,4	25	250
4480.B08	M8	110	80	75	12	5,5	150	14,5	15	150
4480.B10	M10	125	90	87	15	6,0	300	25,5	10	100
4480.B12	M12	125	85	105	17	8,0	450	39,0	10	50
4480.B14	M14	140	90	120	17	9,0	650	58,5	5	30
4480.B16	M16	170	115	137	23	11,0	800	88,0	5	25
4480.B20	M20	200	135	155	27	14,0	1200	157,0	1	15
4480.B24	M24	255	175	195	30	16,0	1800	265,0	1	10
4480.B30	M30	255	165	210	30	19,0	2800	400,0	1	5
4480.B36	M36	295	185	480	35	25,0	4000	710,0	1	4

5

## Napínák DIN 1480 hák-hák

**povrch:** galvanický zinkochromát (bílý) > 8µm  
**materiál:** kovaná ocel S235JR, tř.4.6, Re 235MPa



## Turnbuckle DIN 1480 hook-hook

**finish:** galvanized > 8µm  
**material:** forged steel St37-2

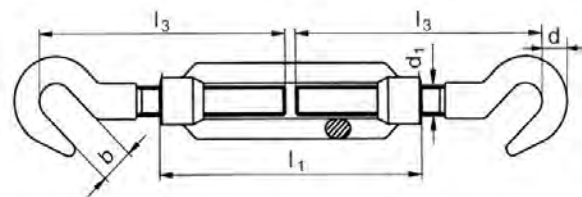

Kód Art. No.	závit thread	l1 mm	l2 mm	l3 mm	b mm	d mm	nosnost WLL kg	kg/100ks kg/100pcs	balení/ks bag/pcs	karton/ks carton/pcs
4480.C05	M5	70	50	55	8	5	60	5	25	500
4480.C06	M6	110	85	73	9	6	80	9	25	250
4480.C08	M8	110	80	82	10	8	120	16	15	150
4480.C10	M10	125	90	97	15	10	180	28	10	100
4480.C12	M12	125	85	117	16	12	260	43	10	50
4480.C14	M14	140	90	120	16	14	360	63	5	30
4480.C16	M16	170	115	135	21	17	500	94	5	25
4480.C20	M20	200	135	152	21	23	800	175	1	15
4480.C24	M24	255	175	195	26	26	1200	290	1	10
4480.C30	M30	255	165	220	30	30	1800	460	1	10
4480.C36	M36	295	185	240	30	35	2600	780	1	5

## Napínák DIN 1480 k navaření

**povrch:** galvanický zinkochromát (bílý) > 8µm

**materiál:** kovaná ocel S235JR, tř.4.6, Re 235MPa

### Turnbuckle DIN 1480 with stubs

**finish:** galvanized > 8µm

**material:** forged steel St37-2

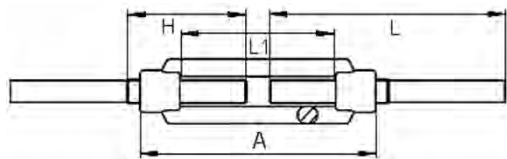

Kód Art. No.	závit thread	A mm	L1 mm	L mm	H mm	nosnost WLL kg	kg/100ks kg/100pcs	balení/ks bag/pcs	karton/ks carton/pcs
4480.E08	M8	110	80	120	65	300	16	15	150
4480.E10	M10	125	89	150	75	500	28	10	100
4480.E12	M12	125	83	150	75	700	42	10	50
4480.E14	M14	140	92	165	90	950	62	5	30
4480.E16	M16	170	116	200	100	1300	93	5	25
4480.E20	M20	200	132	220	120	2000	165	1	15
4480.E24	M24	255	177	260	150	3000	275	1	10
4480.E30	M30	255	165	260	160	4800	415	1	5
4480.E36	M36	295	185	300	180	7100	730	1	4

## Napínák DIN 1480 s vidlicemi

**povrch:** galvanický zinkochromát (bílý) > 8µm

**materiál:** kovaná ocel S235JR, tř.4.6, Re 235MPa

### Turnbuckle DIN 1480 with jaws

**finish:** galvanized > 8µm

**material:** forged steel St37-2

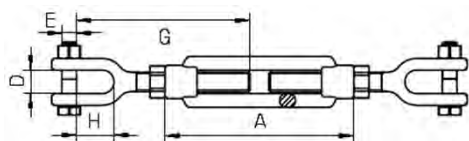

Kód Art. No.	závit thread	A mm	D mm	E mm	G mm	nosnost WLL kg	kg/100ks kg/100pcs	balení/ks bag/pcs	karton/ks carton/pcs
4480.G12	M12	125	15	M10	150	700	60	5	50
4480.G16	M16	170	20	M12	172	1300	115	5	25
4480.G20	M20	200	23	M16	185	2000	196	1	15
4480.G24	M24	255	29	M20	215	3000	339	1	10

## Napínák DIN 1480 s plochými konci

**povrch:** galvanický zinkochromát (bílý) > 8µm

**materiál:** kovaná ocel S235JR, tř.4.6, Re 235MPa

### Turnbuckle DIN 1480 flat

**finish:** galvanized > 8µm

**material:** forged steel St37-2

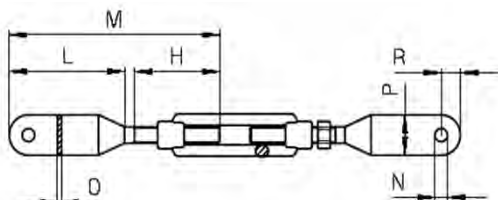

Kód Art. No.	závit thread	L mm	M mm	N mm	O mm	R mm	nosnost WLL kg	kg/100ks kg/100pcs	balení/ks bag/pcs	karton/ks carton/pcs
4480.P12	M12	75	165	13	5	10	700	50	10	50
4480.P16	M16	135	240	14	8	14	1300	105	5	30
4480.P20	M20	135	240	17	9	16	2000	180	1	25
4480.P24	M24	145	305	22	10	18	3000	310	1	20

## Oko pro napínáky

**povrch:** galvanický zinkochromát (bílý) > 8µm

**materiál:** kovaná ocel S235JR, tř.4.6, Re 235MPa

### Turnbuckle Eye Bolt

**finish:** galvanized > 8µm

**material:** forged steel St37-2

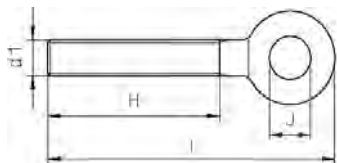

Kód Art. No.	závit	thread	d1 mm	H mm	J mm	I mm	nosnost WLL kg	kg/100ks kg/100pcs	balení/ks bag/pcs	karton/ks carton/pcs
4481.06L	levý	left	M6	55	8	80	100	1,6	25	1 200
4481.06P	pravý	right								
4481.08L	levý	left	M8	60	10	90	150	2,9	25	600
4481.08P	pravý	right								
4481.10L	levý	left	M10	70	14	95	300	5,2	20	400
4481.10P	pravý	right								
4481.12L	levý	left	M12	75	17	110	450	9,4	10	200
4481.12P	pravý	right								
4481.16L	levý	left	M16	100	22	145	800	22,5	5	80
4481.16P	pravý	right								
4481.20L	levý	left	M20	120	23	175	1200	39,5	5	50
4481.20P	pravý	right								
4481.24L	levý	left	M24	150	27	220	1800	72,0	1	30
4481.24P	pravý	right								
4481.30L	levý	left	M30	160	30	235	2600	112,0	1	20
4481.30P	pravý	right								

5

## Hák pro napínáky

**povrch:** galvanický zinkochromát (bílý) > 8µm

**materiál:** kovaná ocel S235JR, tř.4.6, Re 235MPa

### Turnbuckle Hook Bolt

**finish:** galvanized > 8µm

**material:** forged steel St37-2

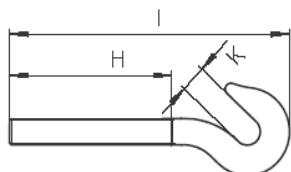

Kód Art. No.	závit	thread	d1 mm	H mm	I mm	K mm	nosnost WLL kg	kg/100ks kg/100pcs	balení/ks bag/pcs	karton/ks carton/pcs
4482.06L	levý	left	M6	55	85	8	80	1,7	25	1 200
4482.06P	pravý	right								
4482.08L	levý	left	M8	60	90	10	120	3,6	25	500
4482.08P	pravý	right								
4482.10L	levý	left	M10	65	105	14	180	6,3	20	300
4482.10P	pravý	right								
4482.12L	levý	left	M12	80	125	16	260	11,1	10	200
4482.12P	pravý	right								
4482.16L	levý	left	M16	100	160	18	500	26,1	5	80
4482.16P	pravý	right								
4482.20L	levý	left	M20	120	200	20	800	48,9	5	40
4482.20P	pravý	right								
4482.24L	levý	left	M24	150	250	24	1200	87,0	1	25
4482.24P	pravý	right								
4482.30L	levý	left	M30	160	300	30	1600	139,5	1	15
4482.30P	pravý	right								

## Svorník k navaření

**povrch:** galvanický zinkochromát (bílý) > 8µm  
**materiál:** kovaná ocel S235JR, tř.4.6, Re 235MPa

### Turnbuckle Welding stud

**finish:** galvanized > 8µm  
**material:** forged steel St37-2

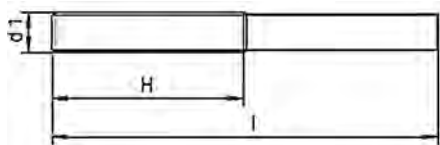

Kód Art. No.	závit	thread	d1 mm	H mm	I mm		nosnost WLL kg	kg/100ks kg/100pcs	balení/ks bag/pcs	karton/ks carton/pcs
4483.10L	levý	left	M10	70	140		500	7,2	20	300
4483.10P	pravý	right								
4483.12L	levý	left	M12	75	150		700	10,7	10	200
4483.12P	pravý	right								
4483.16L	levý	left	M16	105	200		1300	26,5	5	80
4483.16P	pravý	right								
4483.20L	levý	left	M20	125	220		2000	44,3	5	50
4483.20P	pravý	right								
4483.24L	levý	left	M24	150	250		3000	75,5	1	30
4483.24P	pravý	right								
4483.30L	levý	left	M30	160	270		6500	105,0	1	20
4483.30P	pravý	right								

5

## Vydlice pro napínáky

**povrch:** galvanický zinkochromát (bílý) > 8µm  
**materiál:** kovaná ocel S235JR, tř.4.6, Re 235MPa

### Turnbuckle Jaw bolt

**finish:** galvanized > 8µm  
**material:** forged steel St37-2

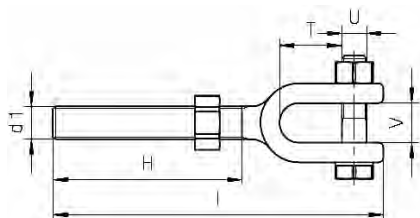

Kód Art. No.	závit	thread	d1 mm	H mm	I mm	U   V mm	nosnost WLL kg	kg/100ks kg/100pcs	balení/ks bag/pcs	karton/ks carton/pcs
4484.06L	levý	left	M6	50	90	5   9	150	6,3	20	300
4484.06P	pravý	right								
4484.08L	levý	left	M8	65	105	6   10	300	9,6	10	200
4484.08P	pravý	right								
4484.10L	levý	left	M10	80	135	8   11	500	12,7	10	150
4484.10P	pravý	right								
4484.12L	levý	left	M12	90	150	10   15	700	19,5	5	100
4484.12P	pravý	right								
4484.16L	levý	left	M16	100	175	13   20	1300	36,5	1	60
4484.16P	pravý	right								
4484.20L	levý	left	M20	115	190	16   24	2000	61,0	1	40
4484.20P	pravý	right								
4484.24L	levý	left	M24	125	230	20   28	3000	112,0	1	20
4484.24P	pravý	right								
4484.30L	levý	left	M30	140	270	24   33	7100	154,3	1	15
4484.30P	pravý	right								



## Matice pro napínák DIN 1480

**povrch:** galvanický zinkochromát (bílý) > 8µm  
**materiál:** kovaná ocel S235JR, tř.4.6, Re 235MPa

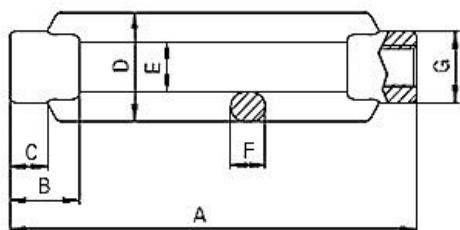

### Body of turnbuckle DIN 1480

**finish:** galvanized > 8µm  
**material:** forged steel St37-2



Kód Art. No.	závit thread	A mm	D mm	B = G mm	E mm	C = F mm	nosnost WLL kg	kg/100ks kg/100pcs	balení/ks bag/pcs	karton/ks carton/pcs
4480.M08	M8	110	23	15	11	8	550	9	25	150
4480.M10	M10	125	30	18	14	9	800	14	20	100
4480.M12	M12	125	34	21	16	11	1100	20	10	50
4480.M14	M14	140	38	25	18	12	1400	29	10	30
4480.M16	M16	170	42	27	20	14	1800	43	5	25
4480.M20	M20	200	52	34	24	17	2800	77	5	15
4480.M24	M24	255	60	39	28	20	4000	115	1	10
4480.M30	M30	255	74	45	34	23	5600	180	1	5
4480.M36	M36	295	86	55	40	28	7800	320	1	4

5

## Matice k napínáku DIN 1479

**povrch:** galvanický zinkochromát (bílý) > 8µm  
**materiál:** kovaná ocel S235JR, tř.4.6, Re 235MPa

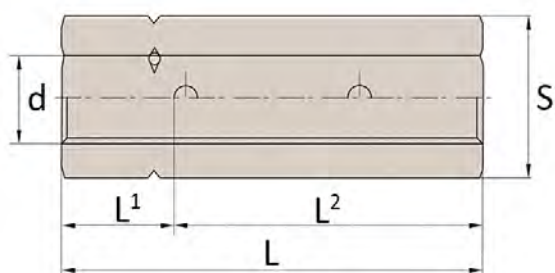

### Body of turnbuckle DIN 1479

**finish:** galvanized > 8µm  
**material:** forged steel St37-2



Kód Art. No.	d thread	L mm	L1 mm	L2 mm	S mm	nosnost WLL kg	kg/100ks kg/100pcs	balení/ks bag/pcs	karton/ks carton/pcs
4479.M08	M8	35	10	25	13	900	3,1	25	600
4479.M10	M10	45	12	33	16	1300	5,8	20	300
4479.M12	M12	55	15	40	18	1650	9,0	10	200
4479.M16	M16	75	20	55	24	2250	18,0	5	100
4479.M20	M20	95	25	70	30	2800	32,0	5	60
4479.M24	M24	115	30	85	36	4000	53,0	1	40
4479.M30	M30	125	35	90	46	5500	108,0	1	20

## Napínák DIN 1478 k navaření

**povrch:** galvanický zinkochromát (bílý) > 8µm  
**materiál:** kovaná ocel S235JR, tř.4.6, Re 235MPa

### Turnbuckle DIN 1478 with stubs

**finish:** galvanized > 8µm  
**material:** forged steel St37-2

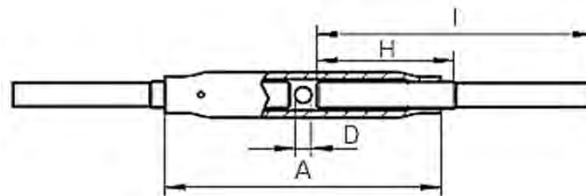

Kód Art. No.	závit thread	A mm	D mm	H mm	I mm	nosnost WLL kg	kg/100ks kg/100pcs	balení/ks bag/pcs	karton/ks carton/pcs
4478.E10	M10	125	8	75	150	500	31	5	75
4478.E12	M12	125	10	75	150	700	44	5	50
4478.E16	M16	170	10	100	200	1300	90	5	25
4478.E20	M20	200	12	120	220	2000	140	2	20
4478.E24	M24	255	12	150	260	3000	265	1	10
4478.E30	M30	255	16	160	260	4800	390	1	5
4478.E36	M36	295	16	180	300	7100	620	1	4
4478.E42	M42	330	20	200	350	9800	1000	1	2
4478.E48	M48	355	20	220	380	13000	1400	1	2

5

## Napínák DIN 1478 s vydlicemi

**povrch:** galvanický zinkochromát (bílý) > 8µm  
**materiál:** kovaná ocel S235JR, tř.4.6, Re 235MPa

### Turnbuckle DIN 1478 with jaws

**finish:** galvanized > 8µm  
**material:** forged steel St37-2

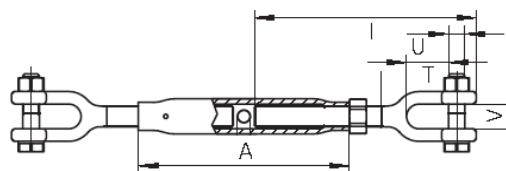

Kód Art. No.	závit thread	A mm	I mm	U mm	T mm	V mm	nosnost WLL kg	kg/100ks kg/100pcs	balení/ks bag/pcs	karton/ks carton/pcs
4478.G08	M8	110	120	9	29	9	300	30	5	80
4478.G10	M10	125	135	9	29	11	500	43	5	50
4478.G12	M12	125	150	11	45	15	700	65	5	30
4478.G16	M16	170	175	13	45	20	1300	125	1	20
4478.G20	M20	200	190	17	60	23	2000	190	1	15
4478.G24	M24	255	230	21	63	29	3000	340	1	5
4478.G30	M30	255	280	25	90	34	4800	490	1	5

**materiál:** nerezavějící ocel A4



**material:** stainless steel AISI 316

Kód Art. No.	závit thread	A mm	I mm	U mm	T mm	V mm	nosnost WLL kg	kg/100ks kg/100pcs	balení/ks bag/pcs	karton/ks carton/pcs
9478.G05	M5	90	72	125	8	9	90	4,7	5	200
9478.G06	M6	110	88	140	9	10	180	8,8	5	100
9478.G08	M8	110	85	155	10	12	300	14,0	5	100
9478.G10	M10	125	93	180	15	15	500	25,3	5	50
9478.G12	M12	125	88	215	16	17	700	39,1	1	25
9478.G16	M16	170	120	260	21	23	1200	57,7	1	20
9478.G20	M20	200	135	307	23	27	1800	86,3	1	10

## Matice napínáku DIN 1478

**povrch:** galvanický zinkochromát (bílý) > 8µm  
**materiál:** kovaná ocel S235JR, tř.4.6, Re 235MPa

### Body of turnbuckle DIN 1478

**finish:** galvanized > 8µm  
**material:** forged steel St37-2

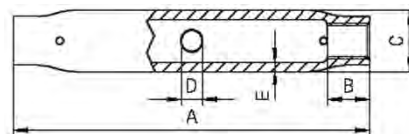
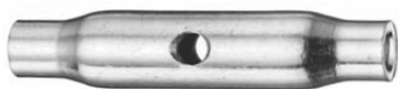

Kód Art. No.	závit thread	A mm	B mm	C mm	D mm	E mm	nosnost WLL kg	kg/100ks kg/100pcs	balení/ks bag/pcs	karton/ks carton/pcs
4478.M06	M6	110	8	17	6	3,0	780	12	10	200
4478.M08	M8	110	10	17	8	3,5	930	14	10	150
4478.M10	M10	125	12	21	8	4,0	1330	18	5	100
4478.M12	M12	125	15	25	10	4,0	1650	25	5	100
4478.M16	M16	170	20	30	10	4,5	2260	47	5	50
4478.M20	M20	200	24	34	12	5,0	2850	58	2	30
4478.M24	M24	255	29	42	12	5,5	3950	105	1	25
4478.M30	M30	255	36	51	16	6,3	5550	160	1	15
4478.M36	M36	295	43	64	16	8,0	8810	280	1	10
4478.M42	M42	330	51	70	20	9,0	10800	455	1	5
4478.M48	M48	355	58	83	20	10,0	14400	610	1	4

5

## Napínák DIN 1478 oko - hák

**povrch:** galvanický zinkochromát (bílý) > 8µm  
**materiál:** kovaná ocel S235JR, tř.4.6, Re 235MPa

### Turnbuckle DIN 1478 with jaws

**finish:** galvanized > 8µm  
**material:** forged steel St37-2

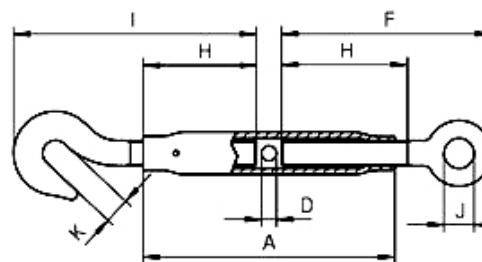

Kód Art. No.	závit thread	A mm	D mm	I mm	J mm	K mm	nosnost WLL kg	kg/100ks kg/100pcs	balení/ks bag/pcs	karton/ks carton/pcs
4478.A08	M8	110	8	98	10	11	300	30	5	80
4478.A10	M10	125	8	116	14	13	500	43	5	50
4478.A12	M12	125	10	146	16	15	700	65	5	30
4478.A16	M16	170	10	165	22	19	1300	125	1	20
4478.A20	M20	200	12	180	24	20	2000	190	1	15
4478.A24	M24	255	12	225	27	26	3000	340	1	5
4478.A30	M30	255	16	255	31	33	4800	490	1	5

## Napínák komerční, oko-hák

**povrch:** galvanický zinkochromát (bílý) > 8µm

**materiál:** zinková slitina ZAMAK2 ZnAl4Cu3



## Turnbuckle commercial, eye-hook

**finish:** galvanized > 8µm

**material:** die cast, zinc alloy

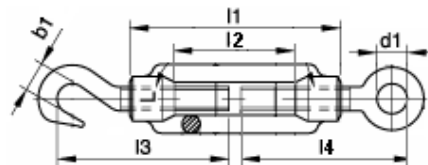

Kód Art. No.	závit thread	l1 mm	l2 mm	l3 = l4 mm	b1 mm	d1 mm	nosnost WLL kg	kg/100ks kg/100pcs	balení/ks bag/pcs	karton/ks carton/pcs
4423.A044	M4	45	25	40	8,5	8	40	1,90	50	1 000
4423.A055	M5	50	30	40	8,5	9	60	3,20	50	500
4423.A057	M5	70	50	50	8,5	9	60	3,70	50	500
4423.A066	M6	60	35	50	10,0	12	90	4,71	50	400
4423.A069	M6	100	70	68	10,0	12	90	6,60	50	300
4423.A087	M8	70	42	57	11,0	12	150	8,32	25	250
4423.A089	M8	110	80	77	11,0	12	150	12,00	25	200
4423.A108	M10	80	50	65	12,0	13	200	15,40	20	140
4423.A112	M10	120	90	88	12,0	13	200	18,80	20	100

- na objednávku se zakončením oko-oko (B), hák-hák (C)

- may be ordered with eye-eye (B), hook-hook (C)

dobací termín 3-4 měsíce od objednání

delivery time 3-4 months from ordering

## Napínač drátu - (plotový)

## Wire tensor

**povrch:** galvanický zinkochromát (bílý) > 8µm

**materiál:** ocel S235JR, pevn.tř.4.6, Re 235MPa

**finish:** galvanized > 8µm

**material:** mild steel St 37-2

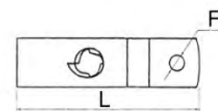
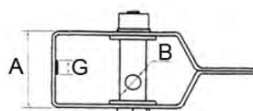

Kód Art. No.	L mm	A mm	B mm	F mm	G mm	kg/100ks kg/100pcs	balení/ks bag/pcs	karton/ks carton/pcs
4424.02	100	30	5	9	7	8,0	25	200
4424.03	120	30	5	9	7	9,4	10	150

**povrch:** zelený lak

**finish:** painted green

4425.02	100	30	5	9	7	8,0	25	200
4425.03	120	30	5	9	7	9,4	10	150

## Kleště štípací

**povrch:** leštěný, lakovaný

**materiál:** čelisti - kal. legovaná ocel, pevn.tř.12.9, Re 1200MPa

ramena - kovaná ocel, pevn.tř.5.8, Re 350MPa

## Bolt cutter

**finish:** polished, painted

**material:** jaws - alloy steel  
handles - forged steel



Kód Art. No.	délka mm	délka inch	střih max. Ø max. cut Ø	kg/1ks kg/1pcs	balení/ks bag/pcs	karton/ks carton/pcs
3552.14	360	14	5 mm	0,75	1	40
3552.18	460	18	6 mm	1,50	1	20
3552.24	610	24	8 mm	2,40	1	10
3552.30	760	30	10 mm	3,90	1	10
3552.36	900	36	12 mm	5,00	1	5
3552.42	1070	42	14 mm	8,00	1	3



# Řetězy a dekorativní řetízky

*Welded and decorative chains*

## Řetěz krátký článek - cívka

**norma:** DIN 766 - nezkoušený

**povrch:** galvanický zinkochromát > 10µm

**materiál:** ocel S235JR, pevn.tř.4.6, Re 235MPa

## Short link welded chain - reel

**norm:** DIN 766 - not proof tested

**finish:** galvanized > 10µm

**material:** carbon steel St37-2



Kód Art. No.	d mm	tol. mm	t mm	b <sup>1</sup> mm	b <sup>2</sup> mm	nosnost WLL kg	kg/100m kg/100m	cívka / m reel / m
7700.03	3	±0,2	16,0	4,5	11	80	15	60
7700.04	4	±0,2	16,0	5,5	14	150	30	50
7700.05	5	±0,3	18,5	6,5	17	250	48	40
7700.06	6	±0,3	18,5	7,5	20	350	76	30
7700.07	7	±0,4	22,0	9,0	24	450	105	20
7700.08	8	±0,4	24,0	10,0	27	600	132	15
7700.10	10	±0,5	28,0	12,0	34	950	205	10

## Řetěz krátký článek - svazek

## Short link welded chain - bundle

6

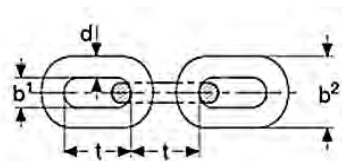

Kód Art. No.	d mm	tol. mm	t mm	b <sup>1</sup> mm	b <sup>2</sup> mm	nosnost WLL kg	kg/100m kg/100m	svazek/m bundle/m
7700.S03	3	±0,2	16,0	4,5	11	80	15	30
7700.S04	4	±0,2	16,0	5,5	14	150	30	30
7700.S05	5	±0,3	18,5	6,5	17	250	48	30
7700.S06	6	±0,3	18,5	7,5	20	350	76	30
7700.S07	7	±0,4	22,0	9,0	24	450	105	20
7700.S08	8	±0,4	24,0	10,0	27	600	132	15
7700.S10	10	±0,5	28,0	12,0	34	950	205	10
7700.S13	13	±0,7	36,0	16,0	44	1100	350	10
7700.S16	16	±0,8	45,0	20,0	54	1600	540	5
7700.S20	20	±1,0	56,0	25,0	68	2500	850	5

**povrch:** bez povrchové úpravy, leštěný

**material:** blank, polished

Kód Art. No.	d mm	tol. mm	t mm	b <sup>1</sup> mm	b <sup>2</sup> mm	nosnost WLL kg	kg/100m kg/100m	svazek/m bundle/m
7700.B04	4	±0,2	16,0	5,5	14	150	30	50
7700.B05	5	±0,3	18,5	6,5	17	250	48	40
7700.B06	6	±0,3	18,5	7,5	20	350	76	30
7700.B08	8	±0,4	24,0	10,0	27	600	132	15
7700.B10	10	±0,5	28,0	12,0	34	950	205	10
7700.B13	13	±0,7	36,0	16,0	44	1100	350	10

**materiál:** nerezavějící ocel A4

**material:** stainless steel AISI 316

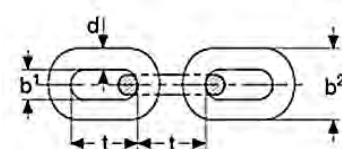

Kód Art. No.	d mm	tol. mm	t mm	b <sup>1</sup> mm	b <sup>2</sup> mm	nosnost WLL kg	kg/100m kg/100m	min. obj. min.order
9700.02	2	±0,1	12,0	3,5	7,5	40	9	20
9700.03	3	±0,2	16,0	4,5	10,5	80	15	10
9700.04	4	±0,2	16,0	5,5	14,0	150	30	10
9700.05	5	±0,3	18,5	6,5	17,0	250	48	10
9700.06	6	±0,3	18,5	7,5	20,0	350	76	5
9700.08	8	±0,4	24,0	10,0	27,0	630	132	5
9700.10	10	±0,5	28,0	12,0	34,0	950	205	1
9700.13	13	±0,6	36,0	16,0	44,0	1100	350	1
9700.16	16	±0,7	45,0	20,0	54,0	1600	540	1

## Řetěz střední článek "A" - cívka

**norma:** DIN 5685A - nezkoušený

**povrch:** galvanický zinkochromát > 10µm

**materiál:** ocel S235JR, pevn.tř.4.6, Re 235MPa

## Medium link welded chain - reel

**norm:** DIN 5685A- not proof tested

**finish:** galvanized > 10µm

**material:** carbon steel St37-2



Kód Art. No.	d mm	tol. mm	t mm	b <sup>1</sup> mm	b <sup>2</sup> mm	nosnost WLL kg	kg/100m kg/100m	cívka / m reel / m
7701.02	2	±0,1	12	4,0	8	40	6,5	100
7701.03	3	±0,2	16	5,5	12	80	16,0	60
7701.04	4	±0,2	19	7,5	16	150	28,0	50
7701.05	5	±0,3	21	9,5	20	250	46,0	40
7701.06	6	±0,3	24	11,0	24	350	68,0	30
7701.07	7	±0,4	28	13,0	28	450	95,0	20
7701.08	8	±0,4	32	15,0	32	630	120,0	15
7701.10	10	±0,5	40	18,0	40	950	190,0	10

## Řetěz střední článek "A" - svazek

## Medium link welded chain - bundle

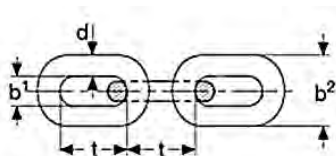

Kód Art. No.	d mm	tol. mm	t mm	b <sup>1</sup> mm	b <sup>2</sup> mm	nosnost WLL kg	kg/100m kg/100m	svazek/m bundle/m
7701.S02	2	±0,1	12	3,5	8	40	6,5	60
7701.S03	3	±0,2	16	5,5	12	80	16,0	30
7701.S04	4	±0,2	19	7,5	16	150	28,0	30
7701.S05	5	±0,3	21	9,5	20	250	46,0	30
7701.S06	6	±0,3	24	12,0	24	350	68,0	30
7701.S07	7	±0,4	28	14,0	28	450	95,0	20
7701.S08	8	±0,4	32	16,0	32	630	120,0	15
7701.S10	10	±0,5	40	20,0	40	950	190,0	10
7701.S13	13	±0,7	52	26,0	52	630	120,0	5
7701.S16	16	±0,8	64	32,0	64	950	190,0	5

## Řetěz kroucený - tvar "X"

**norma:** DIN 5685A - nezkoušený

**povrch:** galvanický zinkochromát > 10µm

**materiál:** ocel S235JR, pevn.tř.4.6, Re 235MPa

## Twist link welded chain

**norm:** DIN 5685A- not proof tested

**finish:** galvanized > 10µm

**material:** carbon steel St37-2

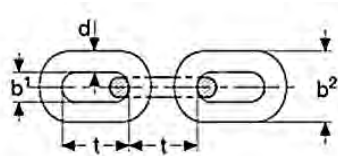

Kód Art. No.	d mm	tol. mm	t mm	b <sup>1</sup> mm	b <sup>2</sup> mm	nosnost WLL kg	kg/100m kg/100m	cívka / m reel / m
7704.02	2	±0,2	11,0	3,2	7,5	40	7	100
7704.03	3	±0,2	15,0	5,0	11,5	70	16	60
7704.04	4	±0,2	17,5	6,0	15,0	120	28	50
7704.05	5	±0,3	19,5	7,0	18,0	200	46	40
7704.06	6	±0,3	22,0	9,0	22,0	300	68	30
7704.08	8	±0,4	29,0	12,0	30,0	500	120	15

## Řetěz dlouhý článek "C" - cívka

**norma:** DIN 763, DIN 5685C - nezkoušený  
**povrch:** galvanický zinkochromát > 10µm  
**materiál:** ocel S235JR, pevn.tř.4.6, Re 235MPa

### Long link welded chain - reel

**norm:** DIN 763 - not proof tested  
**finish:** galvanized > 10µm  
**material:** carbon steel St37-2



Kód Art. No.	d mm	tol. mm	t mm	b <sup>1</sup> mm	b <sup>2</sup> mm	nosnost WLL kg	kg/100m kg/100m	cívka / m reel / m
7702.02	2	±0,2	22	4,0	8	40	6	100
7702.03	3	±0,2	26	5,5	12	80	14	60
7702.04	4	±0,2	32	7,5	16	150	25	50
7702.05	5	±0,3	35	9,5	20	250	40	40
7702.06	6	±0,3	42	11,0	24	350	60	30
7702.07	7	±0,4	49	13,0	28	450	82	20
7702.08	8	±0,4	52	15,0	32	600	105	15
7702.10	10	±0,5	65	19,0	40	950	165	10

## Řetěz dlouhý článek "C" - svazek

### Long link welded chain - bundle

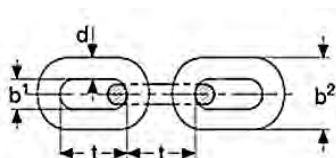

Kód Art. No.	d mm	tol. mm	t mm	b <sup>1</sup> mm	b <sup>2</sup> mm	nosnost WLL kg	kg/100m kg/100m	svazek/m bundle/m
7702.S03	3	±0,2	26	5,5	12	80	14	30
7702.S04	4	±0,2	32	7,5	16	150	25	30
7702.S05	5	±0,3	35	9,5	20	250	40	30
7702.S06	6	±0,3	42	11,0	24	350	60	30
7702.S07	7	±0,4	49	13,0	28	450	82	20
7702.S08	8	±0,4	52	15,0	32	600	105	15
7702.S10	10	±0,5	65	19,0	40	950	165	10
7702.S13	13	±0,7	82	24,0	52	1600	275	10
7702.S16	16	±0,8	100	30,0	64	2400	420	5
7702.S20	20	±1,0	120	32,0	74	3800	660	5

**povrch:** bez povrchové úpravy, leštěný

**material:** blank, polished

Kód Art. No.	d mm	tol. mm	t mm	b <sup>1</sup> mm	b <sup>2</sup> mm	nosnost WLL kg	kg/100m kg/100m	svazek/m bundle/m
7702.B03	3	±0,1	26	5,5	12	80	14	60
7702.B04	4	±0,2	32	7,5	16	150	25	50
7702.B05	5	±0,2	35	9,5	20	250	40	40
7702.B06	6	±0,3	42	11,0	24	350	60	30
7702.B08	8	±0,3	52	15,0	32	630	105	15
7702.B10	10	±0,4	65	19,0	40	950	165	10
7702.B13	13	±0,5	82	24,0	52	1600	275	10

**materiál:** nerezavějící ocel A4

**material:** stainless steel AISI 316



Kód Art. No.	d mm	tol. mm	t mm	b <sup>1</sup> mm	b <sup>2</sup> mm	nosnost WLL kg	kg/100m kg/100m	min. obj. min.order
9702.02	2	±0,1	22	4,0	8	40	6	20
9702.03	3	±0,1	26	5,5	12	80	14	10
9702.04	4	±0,2	32	7,5	16	150	25	10
9702.05	5	±0,2	35	9,5	20	250	40	10
9702.06	6	±0,3	42	11,0	24	350	60	5
9702.08	8	±0,3	52	15,0	32	630	105	5
9702.10	10	±0,4	65	19,0	40	950	165	5
9702.13	13	±0,4	82	24,0	52	1600	275	1
9702.16	16	±0,5	100	30,0	64	2400	420	1



## Řetěz uzlovaný - cívka

norma: DIN 5686

povrch: galvanický zinkochromát > 10µm

materiál: ocel S235JR, pevn.tř.4.6, Re 235MPa

### Knotted chain DIN 5686 - reel

finish: galvanized > 10µm

material: carbon steel St37-2



Kód Art. No.	d mm	tol. mm	t mm	b mm	nosnost WLL kg	kg/100m kg/100m	cívka / m reel / m
7708.14	1,4	±0,1	20	6,5	10	3,80	120
7708.16	1,6	±0,1	22	7,0	20	4,60	90
7708.18	1,8	±0,1	25	8,0	30	6,20	90
7708.20	2,0	±0,1	28	9,0	40	7,50	60
7708.22	2,2	±0,1	31	10,0	50	9,50	60
7708.25	2,5	±0,1	35	11,0	65	12,50	50
7708.28	2,8	±0,2	39	13,0	80	15,50	40
7708.31	3,1	±0,2	40	14,0	100	18,00	30
7708.34	3,4	±0,2	44	15,0	120	22,00	30
7708.38	3,8	±0,2	46	17,0	150	28,00	30
7708.42	4,2	±0,2	50	19,0	180	36,00	30

## Řetěz uzlovaný - svazek

### Knotted chain DIN 5686 - bundle

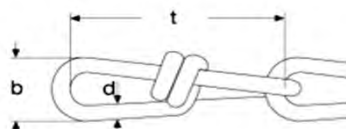

Kód Art. No.	d mm	tol. mm	t mm	b mm	nosnost WLL kg	kg/100m kg/100m	svazek/m bundle/m
7708.S16	1,6	±0,1	22	7,0	20	4,60	60
7708.S18	1,8	±0,1	25	8,0	30	6,20	60
7708.S20	2,0	±0,1	28	9,0	40	7,50	60
7708.S22	2,2	±0,1	31	10,0	50	9,50	60
7708.S25	2,5	±0,1	35	11,0	65	12,50	30
7708.S28	2,8	±0,2	39	13,0	80	15,50	30
7708.S31	3,1	±0,2	40	14,0	100	18,00	30

materiál: nerezavějící ocel A4

material: stainless steel AISI 316



Kód Art. No.	d mm	tol. mm	t mm	b <sup>1</sup> mm	b <sup>2</sup> mm	nosnost WLL kg	kg/100m kg/100m	min. obj. min.order
9708.18	1,8	±0,1	25	8,0		30	6,20	10
9708.20	2,0	±0,1	28	9,0		40	7,50	10
9708.22	2,2	±0,1	31	10,0		50	9,50	10
9708.25	2,5	±0,1	35	11,0		65	12,50	10

## Řetěz plastový

materiál: polyetylén

barva: CB červeno-bílá, ZC žluto-černá, B bílá, C černá

### Plastic chain

material: polyethylene

colours: CB - red-white, ZC - yellow-black, B - white, C - black

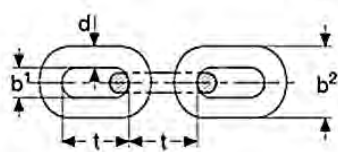

Kód Art. No.	d mm	t mm	b2 mm	barva colour	nosnost WLL kg	kg/100m kg/100m	svazek/m bundle/m
7723.CB4	4	16	13,5	CB - červeno-bílá	6	3,1	30
7723.ZC4	4	16	13,5	ZC - žluto-černá	6	3,1	30
7723.B06	6	27	20,5	B - bílá	10	6,1	30
7723.C06	6	27	20,5	C - černá	10	6,1	30
7723.CB6	6	27	20,5	CB - red-white	10	6,1	30
7723.ZC6	6	27	20,5	ZC - yellow-black	10	6,1	30
7723.B08	8	38	26,5	B - white	15	9,5	25
7723.C08	8	38	26,5	C - black	15	9,5	25
7723.CB8	8	38	26,5	CB - červeno-bílá	15	9,5	25
7723.ZC8	8	38	26,5	ZC - žluto-černá	15	9,5	25

## Řetěz zamykací - oválný

**povrch:** galvanický zinkochromát > 10µm

**materiál:** kalená ocel

**Antitheft chain**

**finish:** galvanized > 10µm

**material:** case hardened steel

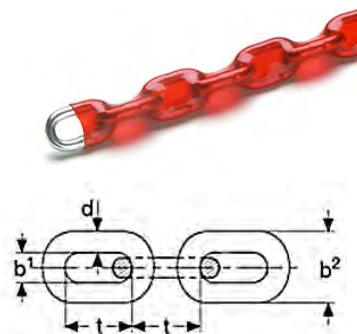

Kód Art. No.	d mm	t mm	b1 mm	délka mm length mm	nosnost WLL kg	kg/100ks kg / 100ks	balení / ks pack / pc
7725.046	4,5	20	8	600	250	24	1
7725.048	4,5	20	8	800	250	32	1
7725.050	4,5	20	8	1000	250	40	1
7725.069	6,0	24	11	900	400	78	1
7725.089	8,0	32	14	900	700	111	1
7725.092	8,0	32	14	1200	700	148	1
7725.100	8,0	32	14	2000	700	246	1

## Řetěz bezpečnostní - hranatý

**povrch:** galvanický zinkochromát > 10µm

**materiál:** kalená logovaná ocel

**Square link asymmetric security chain**

**finish:** galvanized > 10µm

**material:** case hardened alloy steel

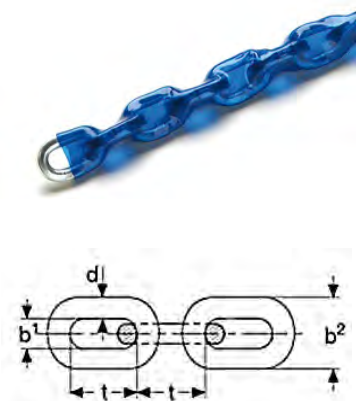

Kód Art. No.	d mm	t mm	b1 mm	délka mm length mm	nosnost WLL kg	kg/100ks kg / 100ks	balení / ks pack / pc
7726.066	6,0	24	11	600	400	62	1
7726.068	6,0	24	11	800	400	78	1
7726.070	6,0	24	11	1000	400	93	1
7726.088	8,0	32	14	800	700	123	1
7726.090	8,0	32	14	1000	700	148	1
7726.092	8,0	32	14	1200	700	185	1
7726.095	8,0	32	14	1500	700	222	1
7726.110	10,0	42	18	1000	900	196	1
7726.112	10,0	42	18	1200	900	235	1
7726.115	10,0	42	18	1500	900	294	1
7726.120	10,0	42	18	2000	900	392	1

## Řetěz vysokopevnostní tř.8

**norma:** EN 818-2 - bezpečnostní faktor 4

**povrch:** černěno oxidací, konzervováno

**materiál:** legovaná ocel tř. 8

**Alloy steel chain G80**

**norm:** EN 818-2 - safety factor 4

**finish:** black boiled

**material:** alloy steel grade 80

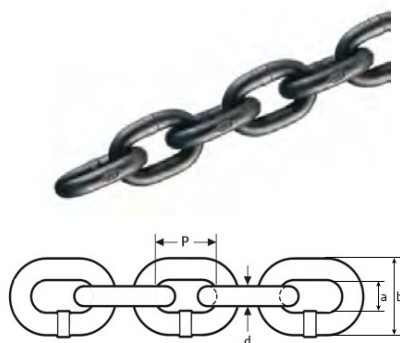

Kód Art. No.	d mm	tol. (d) +/- mm	a mm	b mm	P mm	nosnost WLL (kg)	zlom nosn. BLL (kg)	kg / m kg / m
8818.06	6	0,24	7,8	22,2	18	1120	4520	0,80
8818.07	7	0,28	9,1	25,9	21	1500	6160	1,10
8818.08	8	0,32	10,4	29,6	24	2000	8040	1,40
8818.10	10	0,40	13,0	37,0	30	3150	12600	2,20
8818.13	13	0,52	16,9	48,1	39	5300	21200	3,80
8818.16	16	0,64	20,8	59,2	48	8000	32200	5,70
8818.18	18	0,90	23,4	66,6	54	10000	40700	7,30
8818.20	20	1,00	26,0	74,0	60	12500	50300	9,00
8818.22	22	1,10	28,6	81,4	66	15000	60800	10,90
8818.26	26	1,30	33,8	96,2	78	21200	84900	15,20

## Řetěz ozdobný - hladký

**materiál:** ocel S235JR, pevn.tř.4.6, Re 235MPa

**povrch:** N - poniklovaný

**Decorative chain**

**finish:** nickel plated

**material:** mild steel St37-2



Kód Art. No.	d mm	t mm	b <sup>1</sup> mm	b <sup>2</sup> mm	nosnost WLL kg	kg/100m kg/100m	m / cívka m / reel
7801.20N	2,0	13,5	4,5	8,5	10	7,7	25
7801.22N	2,2	15,2	6,2	10,6	15	7,1	25
7801.30N	3,0	19,0	7,0	13,0	25	17,5	25

**povrch:** M - pomosazený, Br - brunýrovaný

**finish:** M - brass plated, Br - bronzed

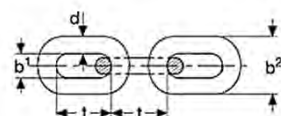

Kód Art. No.	d mm	t mm	b <sup>1</sup> mm	b <sup>2</sup> mm	nosnost WLL kg	kg/100m kg/100m	m / cívka m / reel
7801.20M	2,0	13,5	4,5	8,5	10	7,7	25
7801.22M	2,2	15,2	6,2	10,6	15	7,1	25
7801.30M	3,0	19,0	7,0	13,0	25	17,5	25
7801.30Br	3,0	24,0	8,0	14,0	25	15,3	25

## Řetěz ozdobný - tepaný

**materiál:** ocel S235JR, pevn.tř.4.6, Re 235MPa

**povrch:** poniklovaný

**Decorative wrought chain**

**finish:** nickel plated

**material:** mild steel St37-2



Kód Art. No.	d mm	t mm	b <sup>2</sup> mm	nosnost WLL kg	kg/100m kg/100m	m / cívka m / reel
7805.20N	2,0	16	10	12	8,0	30
7805.23N	2,3	20	11	15	10,0	20
7805.28N	2,8	28	14	18	14,0	20

**povrch:** pomosazený

**finish:** brass plated



Kód Art. No.	d mm	t mm	b <sup>2</sup> mm	nosnost WLL kg	kg/100m kg/100m	m / cívka m / reel
7805.20M	2,0	16	10	12	8,0	30
7805.23M	2,3	20	11	15	10,0	20
7805.28M	2,8	28	14	18	14,0	20

**povrch:** brunýrovaný

**finish:** bronzed

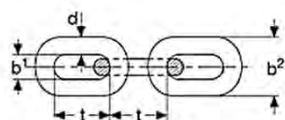

Kód Art. No.	d mm	t mm	b <sup>2</sup> mm	nosnost WLL kg	kg/100m kg/100m	m / cívka m / reel
7805.20Br	2,0	16	10	12	8,0	30
7805.23Br	2,3	20	11	15	10,0	20
7805.28Br	2,8	28	14	18	14,0	20

**povrch:** černý pozink

**finish:** black zink

Kód Art. No.	d mm	t mm	b <sup>2</sup> mm	nosnost WLL kg	kg/100m kg/100m	m / cívka m / reel
7805.20C	2,0	16	10	12	8,0	30
7805.23C	2,3	20	11	15	10,0	20
7805.28C	2,8	28	14	18	14,0	20

## Řetěz ozdobný - lustrový

**materiál:** ocel S235JR, pevn.tř.4.6, Re 235MPa

**povrch:** poniklovaný

**Decorative chandelier chain**

**finish:** nickel plated

**material:** mild steel St37-2



Kód	d	t	b <sup>2</sup>			nosnost	kg/100m	m / cívka
Art. No.	mm	mm	mm			WLL kg	kg/100m	m / reel
7808.23N	2,3	25	16			13	11,0	20
7808.28N	2,8	39	20			17	13,4	20

**povrch: pomosazený**



**finish:** brass plated

Kód	d	t	b <sup>2</sup>			nosnost	kg/100m	m / cívka
Art. No.	mm	mm	mm			WLL kg	kg/100m	m / reel
7808.23M	2,3	25	16			13	11,0	20
7808.28M	2,8	39	20			17	13,4	20

**povrch: brunýrovaný**

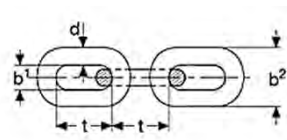

**finish:** bronzed

Kód	d	t	b <sup>2</sup>			nosnost	kg/100m	m / cívka
Art. No.	mm	mm	mm			WLL kg	kg/100m	m / reel
7808.23Br	2,3	25	16			13	11,0	20
7808.28Br	2,8	39	20			17	13,4	20

**povrch: černý pozink**



**finish:** black zinc

Kód	d	t	b <sup>2</sup>			nosnost	kg/100m	m / cívka
Art. No.	mm	mm	mm			WLL kg	kg/100m	m / reel
7808.23C	2,3	25	16			13	11,0	20
7808.28C	2,8	39	20			17	13,4	20

## Řetěz jednoduchý

**materiál:** ocel S235JR, pevn.tř.4.6, Re 235MPa

**povrch:** poniklovaný

**Jack chain**

**finish:** nickel plated

**material:** mild steel St37-2



Kód	d	t	b			nosnost	kg/100m	m / cívka
Art. No.	mm	mm	mm			WLL kg	kg/100m	m / reel
7814.13N	1,3	8,2	5,2			7	3,0	25
7814.16N	1,6	12,2	7,8			10	5,8	25

**povrch: pomosazený**

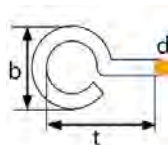

**finish:** brass plated

Kód	d	t	b			nosnost	kg/100m	m / cívka
Art. No.	mm	mm	mm			WLL kg	kg/100m	m / reel
7814.13M	1,3	8,2	5,2			7	3,0	25
7814.18M	1,8	18,0	9,0			15	7,7	25

**povrch: pozinkovaný**

**finish:** galvanized

Kód	d	t	b			nosnost	kg/100m	m / cívka
Art. No.	mm	mm	mm			WLL kg	kg/100m	m / reel
7814.18Z	1,8	18,0	9,0			15	7,7	25

## Řetěz hodinový

**materiál:** ocel S235JR, pevn.tř.4.6, Re 235MPa

**povrch:** N - poniklovaný

**Clockwork chain**

**finish:** nickel plated

**material:** mild steel St37-2



Kód Art. No.	d mm	b <sup>2</sup> mm	t mm			nosnost WLL kg	kg/100m kg/100m	m / cívka m / reel
7815.10N	1,0	4,5	6,5			5	2,0	25
7815.12N	1,2	5,0	7,0			6	2,7	25
7815.16N	1,6	6,0	8,0			8	5,0	10

**povrch: M - pomosazený**

**finish: M - brass plated**

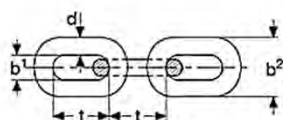

Kód Art. No.	d mm	b <sup>2</sup> mm	t mm			nosnost WLL kg	kg/100m kg/100m	m / cívka m / reel
7815.10M	1,0	4,5	6,5			5	2,0	25
7815.12M	1,2	5,0	7,0			6	2,7	25
7815.16M	1,6	6,0	8,0			8	5,0	10

## Řetěz ozdobný - kroucený

**materiál:** ocel S235JR, pevn.tř.4.6, Re 235MPa

**povrch:** N - poniklovaný

**Decorative chain - twisted**

**finish:** nickel plated

**material:** mild steel St37-2



Kód Art. No.	d mm	b <sup>2</sup> mm	t mm			nosnost WLL kg	kg/100m kg/100m	m / cívka m / reel
7816.10N	1,0	3,5	3,3			5	2,5	25
7816.12N	1,2	4,3	3,5			7	3,7	25
7816.15N	1,5	5,5	4,7			10	5,9	25
7816.18N	1,8	6,7	7,1			15	7,0	25
7816.20N	2,0	7,2	6,6			20	9,7	25
7816.30N	3,0	12,0	10,0			30	15,3	10

**povrch: M - pomosazený**

**finish: M - brass plated**

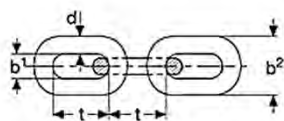

Kód Art. No.	d mm	b <sup>2</sup> mm	t mm			nosnost WLL kg	kg/100m kg/100m	m / cívka m / reel
7816.10M	1,0	3,5	3,3			5	2,5	25
7816.12M	1,2	4,3	3,5			7	3,7	25
7816.15M	1,5	5,5	4,7			10	5,9	25
7816.18M	1,8	6,7	7,1			15	7,0	25
7816.20M	2,0	7,2	6,6			20	9,7	25
7816.30M	3,0	12,0	10,0			30	15,3	10

## Řetěz patentní

**materiál:** ocel S235JR, pevn.tř.4.6, Re 235MPa

**povrch:** N - poniklovaný, M - pomosazený, Z - pozinkovaný

**Sash chain**

**material:** mild steel St37-2

**finish:** N - nickel plated

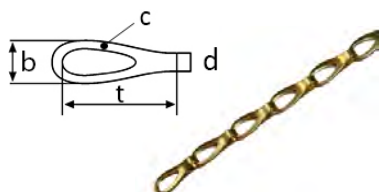

Kód Art. No.	d mm	b mm	t mm	c mm		nosnost WLL kg	kg/100m kg/100m	m / cívka m / reel
7817.13N	2,1	4,9	9,0	0,9		5	2,0	25
7817.13M	2,1	4,9	9,0	0,9		5	2,0	25
7817.19Z	2,6	6,7	17,0	1,6		10	2,0	25

## Řetěz kuličkový

**materiál:** mosaz  
**povrch:** N - poniklovaný

**Ball chain**

**finish:** nickel plated  
**material:** brass



Kód Art. No.	d mm	t mm				nosnost WLL kg	kg/100m kg/100m	m / cívka m / reel
7818.24N	2,4	2,9				9	1,2	25
7818.32N	3,2	4,0				13	2,3	25
7818.36N	3,6	4,5				16	2,6	25

**povrch: M - leštěná mosaz**

**finish: M - brass polished**

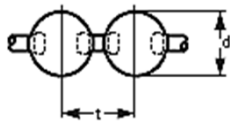

Kód Art. No.	d mm	t mm				nosnost WLL kg	kg/100m kg/100m	m / cívka m / reel
7818.24M	2,4	2,9				9	1,2	25
7818.32M	3,2	4,0				13	2,3	25
7818.36M	3,6	4,5				16	2,6	25

6

## Koncovka na kuličkový řetěz

**materiál:** mosaz  
**povrch:** N - poniklovaný

**Closure for ball chain**

**finish:** nickel plated  
**material:** brass



Kód Art. No.	průměr kuličky řetízku mm		kg/100m kg/100m	ks pcs	ks pcs
7819.K3N	2,1 - 2,4		0,08	100	2 000
7819.K6N	3,2 - 3,6		0,11	100	2 000

**povrch: M - leštěná mosaz**

**finish: M - brass polished**

Kód Art. No.	průměr kuličky řetízku mm		kg/100m kg/100m	ks pcs	ks pcs
7819.K3M	2,1 - 2,4		0,08	100	2 000
7819.K6M	3,2 - 3,6		0,11	100	2 000

## Svorka na kuličkový řetěz

**materiál:** mosaz  
**povrch:** N - poniklovaný

**Clip for ball chain**

**finish:** nickel plated  
**material:** brass



Kód Art. No.	průměr kuličky řetízku mm		kg/100m kg/100m	ks pcs	ks pcs
7820.S3N	2,1 - 2,4		0,08	100	2 000
7820.S6N	3,2 - 3,6		0,11	100	2 000

**povrch: M - leštěná mosaz**

**finish: M - brass polished**

Kód Art. No.	průměr kuličky řetízku mm		kg/100m kg/100m	ks pcs	ks pcs
7820.S3M	2,1 - 2,4		0,08	100	2 000
7820.S6M	3,2 - 3,6		0,11	100	2 000



# Třmeny, Otočná oka

---

*Shackles, Eyes swivel*

## Třmen typu "D"

**povrch:** galvanický zinkochromát (bílý) > 8µm  
**materiál:** ocel S235JR, pevn.tř.4.6, Re 235MPa

**Shackle dee type**

**finish:** galvanized > 8µm  
**material:** forged steel St37-2



Kód Art. No.	d <sub>1</sub> mm	d <sub>4</sub> mm	d <sub>3</sub> mm	b <sub>1</sub> mm	h mm	nosnost WLL kg	kg/100ks kg/100pcs	balení/ks bag/pcs	karton/ks carton/pcs
4447.04	4	4	8	8	15	50	0,8	50	2 500
4447.05	5	5	10	10	20	80	1,5	50	2 000
4447.06	6	6	12	12	24	120	2,5	50	1 500
4447.08	8	8	16	16	32	200	5,5	50	500
4447.10	10	10	20	20	40	320	11,0	25	300
4447.11	11	11	22	22	44	400	14,0	25	200
4447.12	12	12	24	24	48	500	19,0	20	200
4447.14	14	14	28	28	56	650	32,0	10	100
4447.16	16	16	32	32	64	800	42,0	10	60
4447.19	19	19	38	38	76	1100	85,0	5	30
4447.22	22	22	44	44	88	1500	124,0	1	20
4447.25	25	25	50	50	100	2000	183,0	1	15
4447.28	28	28	56	56	112	3000	255,0	1	10
4447.32	32	32	64	64	128	4000	378,0	1	5
4447.35	35	35	70	70	140	4500	505,0	1	5
4447.38	38	38	76	76	152	5000	621,0	1	4
4447.45	45	45	90	90	180	6000	1250,0	1	3
4447.50	50	50	102	102	200	8000	1750,0	1	2

7

**materiál:** nerezavějící ocel A4

**material:** stainless steel AISI 316

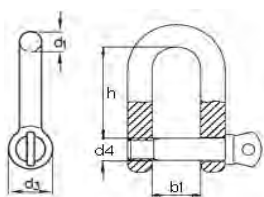

Kód Art. No.	d <sub>1</sub> mm	d <sub>4</sub> mm	d <sub>3</sub> mm	b <sub>1</sub> mm	h mm	nosnost WLL kg	kg/100ks kg/100pcs	balení/ks bag/pcs	karton/ks carton/pcs
9447.04	4	4	9	9	14	120	0,7	10	100
9447.05	5	5	11	18	18	200	1,5	10	100
9447.06	6	6	12	12	22	280	2,6	10	100
9447.08	8	8	16	16	32	560	5,8	5	50
9447.10	10	10	22	22	40	860	11,4	5	50
9447.12	12	12	24	24	48	1150	19,5	1	25
9447.16	16	16	32	32	64	2200	42,0	1	20
9447.19	19	19	38	38	76	3400	85,0	1	20
9447.22	22	22	44	44	88	4500	124,0	1	15
9447.25	25	25	50	50	100	6000	183,0	1	10

bezpečnostní faktor 4 (není určen ke zdvihání břemen nad prostory s pohybem osob)

safety factor 4 (not for overhead lifting)

**Dvoupramenné uchycení břemene nesmí svírat vnitřní úhel větší než 120°. Při symetrickém zatížení není nutno redukovat maximální nosnost**

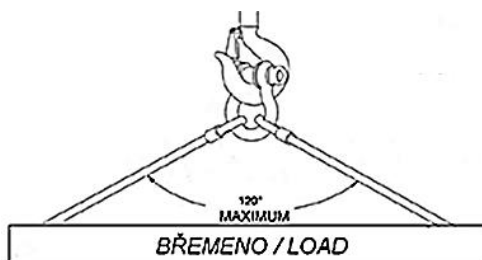

**Never exceed 120° of included angle when two leg slings applied. Shackles symmetrically loaded may be utilized to full WLL.**



## Třmen typu "Omega"

**povrch:** galvanický zinkochromát (bílý) > 8µm  
**materiál:** ocel S235JR, pevn.tř.4.6, Re 235MPa

**Shackle bow type**

**finish:** galvanized > 8µm  
**material:** forged steel St37-2



Kód Art. No.	d <sub>1</sub> mm	d <sub>4</sub> mm	d <sub>3</sub> mm	b <sub>2</sub> mm	h mm	nosnost WLL kg	kg/100ks kg/100pcs	balení/ks bag/pcs	karton/ks carton/pcs
4448.05	5	5	10	15	20	80	1,6	50	2 000
4448.06	6	6	12	18	24	120	2,6	50	1 500
4448.08	8	8	16	24	32	200	5,6	50	500
4448.10	10	10	20	30	40	320	11,3	25	300
4448.11	11	11	22	33	44	400	14,7	25	200
4448.12	12	12	24	36	48	500	20,0	20	150
4448.14	14	14	28	42	56	650	34,0	10	80
4448.16	16	16	32	48	64	800	47,0	5	50
4448.19	19	19	38	60	76	1100	93,0	5	25
4448.22	22	22	44	66	88	1500	136,0	1	20
4448.25	25	25	50	75	100	2000	197,0	1	15
4448.28	28	28	56	84	112	3000	275,0	1	10
4448.32	32	32	64	96	128	4000	403,0	1	5
4447.35	35	35	70	108	135	4500	621,0	1	5
4448.38	38	38	76	126	152	5000	653,0	1	4
4447.45	45	45	90	150	180	6500	1250,0	1	3
4447.50	50	50	102	156	200	8000	1750,0	1	2

**materiál:** nerezavějící ocel A4

**material:** stainless steel AISI 316

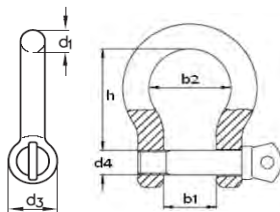

Kód Art. No.	d <sub>1</sub> mm	d <sub>4</sub> mm	d <sub>3</sub> mm	b <sub>2</sub> mm	h mm	nosnost WLL kg	kg/100ks kg/100pcs	balení/ks bag/pcs	karton/ks carton/pcs
9448.04	4	4	8	12	16	120	0,8	10	100
9448.05	5	5	10	15	20	200	1,6	10	100
9448.06	6	6	12	18	24	280	2,7	10	100
9448.08	8	8	16	24	32	560	6,0	5	50
9448.10	10	10	20	30	40	860	12,1	5	50
9448.12	12	12	26	36	48	1150	20,3	1	25
9448.16	16	16	32	48	64	2200	46,0	1	20
9447.19	19	19	38	60	76	3400	85,0	1	20
9447.22	22	22	44	66	88	4500	124,0	1	15
9447.25	25	25	50	75	100	6000	183,0	1	10

bezpečnostní faktor 4 (není určen ke zdvihání břemen nad prostory s pohybem osob)

*safety factor 4 (not for overhead lifting)*

### Redukce nejvyšší nosnosti při bočním zatížení třmene

úhel zatížení vůči svislé rovině	procentní úprava nejvyšší pracovní nosnosti
0°	100% nosnosti
45°	70% nosnosti
90°	50% nosnosti

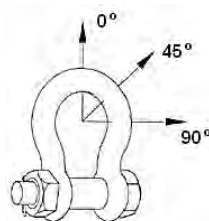

### Side loading reduction of working load limit

angle of side load against vertical line	adjustment of percents for working load limit
0°	100% of WLL
45°	70% of WLL
90°	50% of WLL

## Třmen vysokopevnostní, typ "D"

**povrch:** žárově pozinkovaný > 40µm

**materiál:** ušlechtilá ocel C45E, pevn.tř.6.8, Re 450-600MPa

bezpečnostní faktor 6 (zkušební zatížení 2 x WLL, mezní 6 x WLL)

### High tensile dee shackle

**finish:** hot dipped galvanized > 40µm

**material:** high tensile steel Ck45

safety factor 6 (proof load 2 x WLL, ultimate 6 x WLL)

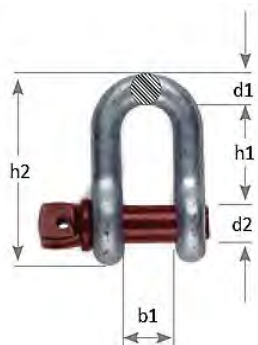

Kód Art. No.	d1 mm	d2 mm	b1 mm	h1 mm	h2 mm	nosnost WLL kg	kg/100ks kg/100pcs	balení/ks bag/pcs	karton/ks carton/pcs
4450.06	6	8	12	22	40	500	4,5	1	500
4450.08	8	10	13	26	49	750	7,8	1	250
4450.10	10	11	17	31	59	1000	12,5	1	150
4450.11	11	13	19	36	68	1500	17,0	1	100
4450.13	13	16	21	41	77	2000	25,0	1	60
4450.16	16	19	27	51	95	3250	53,0	1	40
4450.19	19	22	32	60	116	4750	96,0	1	25
4450.22	22	25	37	71	135	6500	145,0	1	15
4450.25	25	28	43	81	150	8500	210,0	1	10
4450.28	28	32	46	90	172	9500	295,0	1	5
4450.32	32	35	52	100	190	12000	450,0	1	4
4450.35	35	38	57	113	210	13500	600,0	1	3
4450.38	38	41	60	124	230	17000	800,0	1	2
4450.44	44	51	73	146	279	25000	1350,0	1	1
4450.51	51	57	83	171	324	35000	2000,0	1	1

7

## Třmen vysokopevnostní se šroubem, typ "D"

**povrch:** žárově pozinkovaný > 40µm

**materiál:** ušlechtilá ocel C45E, pevn.tř.6.8, Re 450-600MPa

bezpečnostní faktor 6 (zkušební zatížení 2 x WLL, mezní 6 x WLL)

### High tensile dee shackle with bolt

**finish:** hot dipped galvanized > 40µm

**material:** high tensile steel Ck45

safety factor 6 (proof load 2 x WLL, ultimate 6 x WLL)

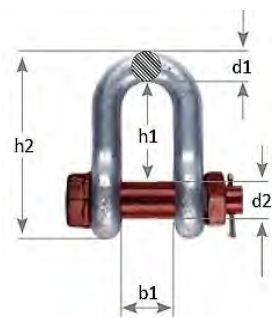

Kód Art. No.	d1 mm	d2 mm	b1 mm	h1 mm	h2 mm	nosnost WLL kg	kg/100ks kg/100pcs	balení/ks bag/pcs	karton/ks carton/pcs
4452.06	6	8	12	22	40	500	4,5	1	500
4452.08	8	10	13	26	49	750	7,8	1	250
4452.10	10	11	17	31	59	1000	12,5	1	150
4452.11	11	13	19	36	68	1500	17,0	1	100
4452.13	13	16	21	41	77	2000	34,0	1	50
4452.16	16	19	27	51	95	3250	62,0	1	30
4452.19	19	22	32	60	115	4750	106,0	1	20
4452.22	22	25	37	71	135	6500	162,0	1	15
4452.25	25	28	43	81	151	8500	235,0	1	10
4452.28	28	32	46	90	172	9500	320,0	1	5
4452.32	32	35	52	100	190	12000	450,0	1	4
4452.35	35	38	57	113	210	13500	600,0	1	3
4452.38	38	41	60	124	230	17000	800,0	1	2
4452.44	44	51	73	146	279	25000	1350,0	1	1
4452.51	51	57	83	171	324	35000	2000,0	1	1

Dvoupramenné uchycení břemene nesmí svírat vnitřní úhel větší než 120°. Při symetrickém zatížení není nutno redukovat maximální nosnost

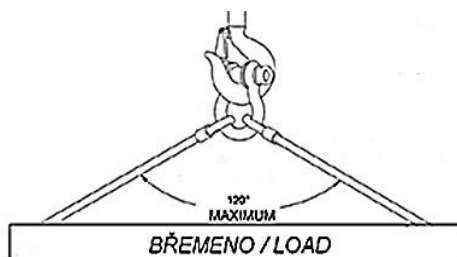

Never exceed 120° of included angle when two leg slings applied. Shackles symmetrically loaded may be utilized to full WLL.

## Třmen vysokopevnostní, typ Omega

**povrch:** žárově pozinkovaný > 40µm

**materiál:** ušlechtilá ocel C45E, pevn.tř.6.8, Re 450-600MPa

bezpečnostní faktor 6 (zkušební zatížení 2 x WLL, mezní 6 x WLL)

**High tensile bow shackle**

**finish:** hot dipped galvanized > 40µm

**material:** high tensile steel Ck45

safety factor 6 (proof load 2 x WLL, ultimate 6 x WLL)

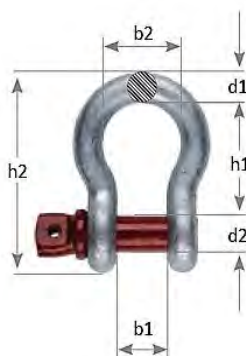

Kód Art. No.	d1 mm	d2 mm	b1   b2 mm	h1 mm	h2 mm	nosnost WLL kg	kg/100ks kg/100pcs	balení/ks bag/pcs	karton/ks carton/pcs
4451.06	6	8	12   20	29	47	500	4,9	1	500
4451.08	8	10	13   21	32	53	750	8,5	1	250
4451.10	10	11	17   26	37	63	1000	14,0	1	150
4451.11	11	13	19   30	43	78	1500	19,5	1	100
4451.13	13	16	21   33	48	83	2000	28,5	1	60
4451.16	16	19	27   43	60	106	3250	60,0	1	40
4451.19	19	22	32   51	71	126	4750	104,0	1	25
4451.22	22	25	37   58	84	148	6500	160,0	1	15
4451.25	25	28	43   68	95	167	8500	230,0	1	10
4451.28	28	32	46   74	108	190	9500	325,0	1	5
4451.32	32	35	52   82	117	210	12000	500,0	1	4
4451.35	35	38	57   92	134	233	13500	680,0	1	3
4451.38	38	41	60   98	145	254	17000	900,0	1	2
4451.44	44	51	73   127	177	314	25000	1500,0	1	1
4451.51	51	57	83   146	195	348	35000	2200,0	1	1

## Třmen vysokopevnostní se šroubem, typ Omega

**povrch:** žárově pozinkovaný > 40µm

**materiál:** ušlechtilá ocel C45E, pevn.tř.6.8, Re 450-600MPa

bezpečnostní faktor 6 (zkušební zatížení 2 x WLL, mezní 6 x WLL)

**High tensile bow shackle with bolt**

**finish:** hot dipped galvanized > 40µm

**material:** high tensile steel Ck45

safety factor 6 (proof load 2 x WLL, ultimate 6 x WLL)

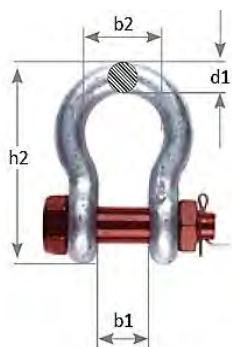

Kód Art. No.	d1 mm	d2 mm	b1   b2 mm	h1 mm	h2 mm	nosnost WLL kg	kg/100ks kg/100pcs	balení/ks bag/pcs	karton/ks carton/pcs
4453.06	6	8	12   20	29	47	500	4,9	1	500
4453.08	8	10	13   21	32	53	750	8,5	1	250
4453.10	10	11	17   26	37	63	1000	14,0	1	150
4453.11	11	13	19   30	43	78	1500	19,5	1	100
4453.13	13	16	21   33	48	83	2000	36,0	1	50
4453.16	16	19	27   43	60	106	3250	70,0	1	30
4453.19	19	22	32   51	71	126	4750	117,0	1	20
4453.22	22	25	37   58	84	148	6500	174,0	1	15
4453.25	25	28	43   68	95	167	8500	260,0	1	10
4453.28	28	32	46   74	108	190	9500	355,0	1	5
4453.32	32	35	52   82	117	210	12000	500,0	1	4
4453.35	35	38	57   92	134	233	13500	680,0	1	3
4453.38	38	41	60   98	145	254	17000	900,0	1	2
4453.44	44	51	73   127	177	314	25000	1500,0	1	1
4453.51	51	57	83   146	195	348	35000	2200,0	1	1

### Redukce nejvyšší nosnosti při bočním zatížení třmene

úhel zatížení vůči svislé rovině	procentní úprava nejvyšší pracovní nosnosti
0°	100% nosnosti
45°	70% nosnosti
90°	50% nosnosti

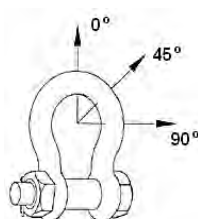

### Side loading reduction of working load limit

angle of side load against vertical line	adjustment of percents for working load limit
0°	100% of WLL
45°	70% of WLL
90°	50% of WLL

## Třmen potrubní ETR

**povrch:** galvanický zinkochromát (bílý) > 8µm  
**materiál:** ocel S275JR, pevn. tř. 5.6, Re 275MPa

**U - Bolt**

**finish:** galvanized > 8µm  
**material:** forged steel St 44-2

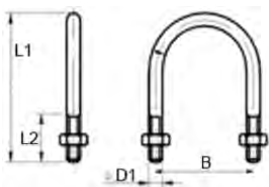

Kód Art. No.	D1	L1 mm	L2 mm	B mm	palce inch	rozsah range mm	kg/100ks kg/100pcs	balení/ks bag/pcs	karton/ks carton/pcs
5120.020	M6	32	20	20	1/4"	8-13	1,57	100	1 500
5120.025	M6	38	20	25	3/8"	12-17	1,82	100	1 200
5120.030	M6	45	30	30	1/2"	15-21	2,10	100	1 000
5120.035	M8	60	30	35	3/4"	20-27	4,30	50	500
5120.042	M8	67	30	42	1"	26-34	5,45	50	500
5120.056	M8	76	35	56	1 1/4"	33-42	6,25	50	300
5120.057	M8	82	35	57	1 1/2"	40-49	6,60	50	300
5120.071	M8	90	35	71	2"	50-60	7,45	50	300
5120.083	M10	105	40	83	2 1/4"	60-70	14,00	25	150
5120.090	M10	117	45	90	2 1/2"	66-76	15,30	25	150
5120.093	M10	120	45	93	2 3/4"	70-82	15,50	25	150
5120.100	M10	123	45	100	3"	80-90	16,10	25	150
5120.118	M12	155	50	118	3 1/2"	90-102	28,50	20	80
5120.121	M12	160	55	121	3 3/4"	100-108	29,30	20	80
5120.135	M12	160	55	135	4"	102-114	29,80	20	80
5120.142	M12	170	55	142	4 1/2"	121-127	31,50	15	60
5120.145	M12	180	65	145	4 3/4"	126-133	32,80	15	60
5120.157	M14	190	70	157	5"	131-140	47,90	10	50
5120.170	M14	200	70	170	5 1/4"	143-153	50,40	5	40
5120.175	M14	208	70	175	5 1/2"	150-159	53,20	5	30

**materiál:** nerezavějící ocel A4

**material:** stainless steel AISI 316

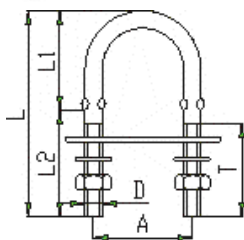

Kód Art. No.	D mm	A mm	L mm	L1 mm	L2 mm	kg/100ks kg/100pcs	balení/ks bag/pcs	karton/ks carton/pcs
9120.046	4	30	60	25	35	1,8	10	100
9120.056	5	30	60	25	35	2,4	10	100
9120.066	6	30	60	25	35	3,6	10	100
9120.069	6	30	90	35	55	3,9	10	100
9120.088	8	35	80	35	45	8,1	5	50
9120.090	8	35	100	40	60	8,7	5	50
9120.113	10	50	130	55	75	13,0	1	50

## Oko otočné na řetěz G-401

**povrch:** žárově pozinkovaný > 40µm

**materiál:** ušlechtilá ocel C45E, pevn.tř.6.8, Re 450-600MPa

### Eye swivel G-401

**finish:** hot dipped galvanized > 40µm

**material:** high tensile steel Ck45



Kód Art. No.	M mm	R mm	B   C mm	D mm	E mm	nosnost WLL kg	kg/100ks kg/100pcs	balení/ks bag/pcs	karton/ks carton/pcs
4591.06	M6	57	17   19	15	29	385	5,8	1	400
4591.08	M8	69	21   25	18	35	565	11,1	1	200
4591.10	M10	87	24   32	25	45	1020	24,3	1	100
4591.12	M12	108	33   38	31	57	1630	50,4	1	50
4591.16	M16	130	40   44	37	70	2350	94,0	1	20
4591.20	M20	147	44   51	44	70	3250	139,0	1	15

## Oko otočné na řetěz G-402

**povrch:** žárově pozinkovaný > 40µm

**materiál:** ušlechtilá ocel C45E, pevn.tř.6.8, Re 450-600MPa

### Eye swivel G-402

**finish:** hot dipped galvanized > 40µm

**material:** high tensile steel Ck45

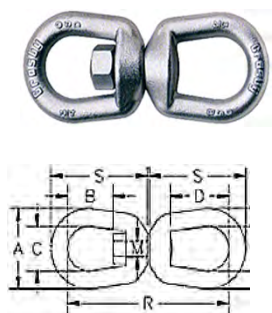

Kód Art. No.	M mm	R mm	B   C mm	D mm	S mm	nosnost WLL kg	kg/100ks kg/100pcs	balení/ks bag/pcs	karton/ks carton/pcs
4592.06	M6	75	17   19	27	43	385	8,8	1	250
4592.08	M8	90	21   25	32	52	565	15,6	1	150
4592.10	M10	109	24   32	38	63	1020	30,5	1	80
4592.12	M12	138	33   38	51	81	1630	60,0	1	40
4592.16	M16	167	40   44	60	98	2350	115,0	1	20
4592.20	M20	183	44   51	67	109	3250	181,0	1	10

## Oko otočné na řetěz G-402

**povrch:** žárově pozinkovaný > 40µm

**materiál:** ušlechtilá ocel C45E, pevn.tř.6.8, Re 450-600MPa

### Eye swivel G-402

**finish:** hot dipped galvanized > 40µm

**material:** high tensile steel Ck45

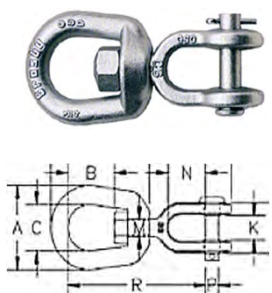

Kód Art. No.	M mm	R mm	B   C mm	N mm	K mm	nosnost WLL kg	kg/100ks kg/100pcs	balení/ks bag/pcs	karton/ks carton/pcs
4593.06	M6	67	17   19	22	12	385	8,1	1	300
4593.08	M8	75	21   25	22	13	565	15,3	1	150
4593.10	M10	92	24   32	27	16	1020	27,7	1	80
4593.12	M12	114	33   38	33	19	1630	62,0	1	40
4593.16	M16	135	40   44	38	24	2350	106,0	1	25
4593.20	M20	154	44   51	44	29	3250	175,0	1	15

## Čeo otočný, oko - oko

materiál: nerez A4 (AISI316)

Swivel, eye - eye

material: stainless steel AISI 316

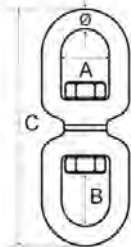

Kód Art. No.	M mm	A mm	B mm	C mm	Ø mm	nosnost WLL kg	kg/100ks kg/100pcs	balení/ks bag/pcs	karton/ks carton/pcs
9595.05	M5	13	14	60	5	150	3,5	20	600
9595.06	M6	14	15	66	6	270	6,1	10	300
9595.08	M8	19	21	90	8	425	11,8	10	200
9595.10	M10	23	26	112	10	750	24,5	5	80
9595.12	M12	33	35	148	13	1125	50,4	5	40
9595.16	M16	40	42	179	16	1500	94,0	1	20
9595.20	M20	50	53	221	20	2000	139,0	1	15

## Čeo otočný, vidlice - oko

materiál: nerez A4 (AISI316)

Swivel, eye - jaw

material: stainless steel AISI 316

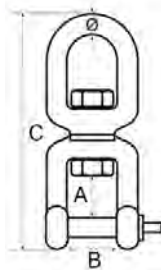

Kód Art. No.	M mm	A mm	B mm	C mm	Ø mm	nosnost WLL kg	kg/100ks kg/100pcs	balení/ks bag/pcs	karton/ks carton/pcs
9596.06	M6	11	12	60	6	270	6,7	20	250
9596.08	M8	15	16	80	8	425	14,5	10	150
9596.10	M10	20	22	103	10	750	28,0	10	80
9596.12	M12	25	26	122	13	1125	62,0	5	40
9596.16	M16	30	32	166	16	1500	117,0	1	20
9596.20	M20	36	40	198	20	2000	179,0	1	15

## Čeo otočný, vidlice - vidlice

materiál: nerez A4 (AISI316)

Swivel, jaw - jaw

material: stainless steel AISI 316

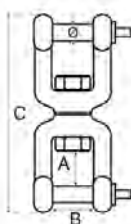

Kód Art. No.	M mm	A mm	B mm	C mm	Ø mm	nosnost WLL kg	kg/100ks kg/100pcs	balení/ks bag/pcs	karton/ks carton/pcs
9597.06	M6	11	12	65	6	270	8,1	20	250
9597.08	M8	15	16	86	8	425	15,3	10	150
9597.10	M10	20	22	111	10	750	27,7	10	80
9597.12	M12	25	26	144	13	1125	62,0	5	40
9597.16	M16	30	32	178	16	1500	106,0	1	20
9597.20	M20	36	40	212	20	2000	175,0	1	15



# Závěsná oka

---

*Eye nuts and bolt*

## Šroub závěsný DIN 580

**povrch:** galvanický zinkochromát (bílý) > 8µm  
**materiál:** ocel C15E, pevn.tř.4.8, Re 250-300MPa  
 bezpečnostní faktor 6

### Eye bolt DIN 580

**finish:** galvanized > 8µm  
**material:** forged steel C15E  
 safety factor 6

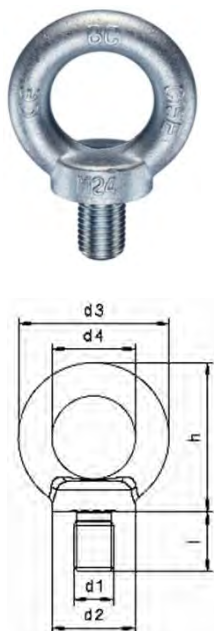

Kód Art. No.	d1 mm	d3 mm	d4 mm	l mm	nosnost kg		kg/100ks kg/100pcs	balení/ks bag/pcs	karton/ks carton/pcs
					WLL 0°	45°			
4580.06	M6	36	20	13	70	50	5,5	25	500
4580.08	M8	36	20	13	140	95	6,0	25	500
4580.10	M10	45	25	17	230	170	11,0	20	250
4580.12	M12	54	30	20	340	240	18,0	10	150
4580.14	M14	54	30	20	500	350	23,0	10	100
4580.16	M16	63	35	27	700	500	28,0	10	80
4580.18	M18	63	35	27	900	600	34,0	5	60
4580.20	M20	72	40	30	1200	830	44,5	5	50
4580.22	M22	72	40	30	1500	950	67,0	5	40
4580.24	M24	90	50	36	1800	1290	91,0	1	30
4580.27	M27	90	50	36	2500	1800	105,0	1	20
4580.30	M30	108	60	45	3600	2500	166,0	1	15
4580.36	M36	126	70	54	5100	3700	265,0	1	10
4580.42	M42	144	80	63	7000	5000	403,0	1	5
4580.48	M48	165	90	68	8600	6100	638,0	1	3
4580.56	M56	185	98	83	11500	8200	880,0	1	2

**povrch:** bez povrchové úpravy - holý

**finish:** blank



Kód Art. No.	d1 mm	d3 mm	d4 mm	l mm	nosnost kg		kg/100ks kg/100pcs	balení/ks bag/pcs	karton/ks carton/pcs
					WLL 0°	45°			
4580.B08	M8	36	20	13	140	95	6,0	25	500
4580.B10	M10	45	25	17	230	170	11,0	20	250
4580.B12	M12	54	30	20	340	240	18,0	10	150
4580.B16	M16	63	35	27	700	500	28,0	10	80
4580.B20	M20	72	40	30	1200	830	44,5	5	50
4580.B24	M24	90	50	36	1800	1290	91,0	1	30
4580.B30	M30	108	60	45	3600	2500	166,0	1	15
4580.B36	M36	126	70	54	5100	3700	265,0	1	10
4580.B42	M42	144	80	63	7000	5000	403,0	1	5
4580.B48	M48	165	90	68	8600	6100	638,0	1	3
4580.B56	M56	185	98	83	11500	8200	880,0	1	2

**materiál:** nerezavějící ocel A4

**material:** stainless steel AISI 316



Kód Art. No.	d1 mm	d3 mm	d4 mm	l mm	nosnost kg		kg/100ks kg/100pcs	balení/ks bag/pcs	karton/ks carton/pcs
					WLL 0°	45°			
9580.06	M6	28	16	11	70	50	2,8	1	400
9580.08	M8	36	20	13	140	95	6,0	1	300
9580.10	M10	45	25	17	230	170	11,0	1	200
9580.12	M12	54	30	20	340	240	18,0	1	120
9580.16	M16	63	35	27	700	500	28,0	1	80
9580.20	M20	72	40	30	1200	830	45,0	1	50
9580.24	M24	90	50	36	1800	1270	74,0	1	30
9580.30	M30	108	60	45	3600	2500	166,0	1	10



## Matice závěsná DIN 582

**povrch:** galvanický zinkochromát (bílý) > 8µm  
**materiál:** ocel C15E, pevn.tř.4.8, Re 250-300MPa  
 bezpečnostní faktor 6

### Eye nut DIN 582

**finish:** galvanized > 8µm  
**material:** forged steel C15E  
 safety factor 6

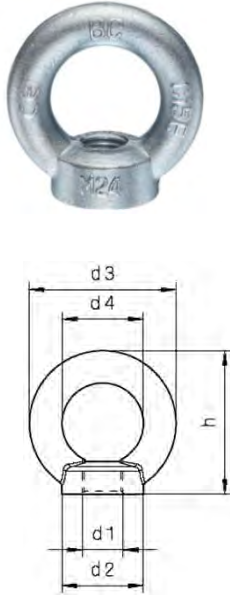

Kód Art. No.	d1 mm	d3 mm	d4 mm	h mm	nosnost kg		kg/100ks kg/100pcs	balení/ks bag/pcs	karton/ks carton/pcs
					WLL 0°	45°			
4582.06	M6	36	20	36	70	50	5,0	25	500
4582.08	M8	36	20	36	140	95	5,0	25	500
4582.10	M10	45	25	45	230	170	9,0	20	250
4582.12	M12	54	30	53	340	240	16,0	10	150
4582.14	M14	54	30	53	500	350	21,0	10	100
4582.16	M16	63	35	62	700	500	24,0	10	80
4582.18	M18	63	35	62	900	600	24,0	5	80
4582.20	M20	72	40	71	1200	830	36,0	5	50
4582.22	M22	72	40	71	1500	950	36,0	5	50
4582.24	M24	90	50	90	1800	1270	76,0	1	30
4582.27	M27	90	50	90	2500	1800	76,0	1	30
4582.30	M30	108	60	109	3600	2500	135,0	1	15
4582.36	M36	126	70	128	5100	3700	208,0	1	10
4582.42	M42	144	80	147	7000	5000	311,0	1	5
4582.48	M48	165	90	168	8600	6100	502,0	1	3
4582.56	M56	185	98	190	11500	8200	715,0	1	3

**povrch:** bez povrchové úpravy - holý

**finish:** blank



Kód Art. No.	d1 mm	d3 mm	d4 mm	h mm	nosnost kg		kg/100ks kg/100pcs	balení/ks bag/pcs	karton/ks carton/pcs
					WLL 0°	45°			
4582.B08	M8	36	20	36	140	95	5,0	25	500
4582.B10	M10	45	25	45	230	170	9,0	20	250
4582.B12	M12	54	30	53	340	240	16,0	10	150
4582.B14	M14	54	30	53	500	350	21,0	10	100
4582.B16	M16	63	35	62	700	500	24,0	10	80
4582.B20	M20	72	40	71	1200	830	36,0	5	50
4582.B24	M24	90	50	90	1800	1270	76,0	1	30
4582.B30	M30	108	60	109	3600	2500	135,0	1	15
4582.B36	M36	126	70	128	5100	3700	208,0	1	10
4582.B42	M42	144	80	147	7000	5000	311,0	1	5
4582.B48	M48	165	90	168	8600	6100	502,0	1	3
4582.B56	M56	18	90	168	11500	8200	715,0	1	3

**materiál:** nerezavějící ocel A4

**material:** stainless steel AISI 316



Kód Art. No.	d1 mm	d3 mm	d4 mm	h mm	nosnost kg		kg/100ks kg/100pcs	balení/ks bag/pcs	karton/ks carton/pcs
					WLL 0°	45°			
9582.06	M6	28	16	28	70	50	2,3	1	400
9582.08	M8	36	20	36	140	95	5,2	1	300
9582.10	M10	45	25	45	230	170	9,4	1	200
9582.12	M12	54	30	53	340	240	16,0	1	150
9582.16	M16	63	35	62	700	500	24,0	1	100
9582.20	M20	72	40	71	1200	830	35,2	1	50
9582.24	M24	90	50	90	1800	1270	70,6	1	30
9582.30	M30	108	60	109	3600	2500	135,0	1	10

## Šroub závěsný DIN 580 - vysokopevnostní

**povrch:** červeně lakovaný

**materiál:** dle ČSN EN 1677, legovaná ocel tř. 8  
bezpečnostní faktor 4

### Eye bolt DIN 580

**finish:** painted red

**material:** alloy steel grade 80  
safety factor 4

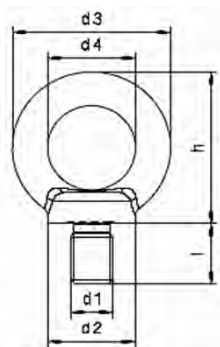

Kód Art. No.	d1 mm	d3 mm	d4 mm	l mm	nosnost kg		kg/100ks kg/100pcs	balení/ks bag/pcs	karton/ks carton/pcs
					WLL 0°	45°			
8580.06	M6	36	20	13	400	100	5,5	25	500
8580.08	M8	36	20	13	800	200	6,0	25	500
8580.10	M10	45	25	17	1000	250	11,0	20	250
8580.12	M12	54	30	20	1600	400	18,0	10	150
8580.14	M14	54	30	20	2000	500	23,0	10	100
8580.16	M16	63	35	27	4000	1000	28,0	10	80
8580.18	M18	63	35	27	5000	1250	34,0	5	60
8580.20	M20	72	40	30	6000	1500	44,5	5	50
8580.22	M22	72	40	30	7000	1750	67,0	5	40
8580.24	M24	90	50	36	8000	2000	91,0	1	30
8580.27	M27	90	50	36	9000	2250	105,0	1	20
8580.30	M30	108	60	45	12000	3000	166,0	1	15
8580.36	M36	126	70	54	16000	4000	265,0	1	10
8580.42	M42	144	80	63	24000	6000	403,0	1	5
8580.48	M48	165	90	68	32000	8000	638,0	1	3
8580.56	M56	185	98	83	45000	11250	880,0	1	2

8

## Matice závěsná DIN 582 - vysokopevnostní

**povrch:** červeně lakovaný

**materiál:** dle ČSN EN 1677, legovaná ocel tř. 8  
bezpečnostní faktor 4

### Eye nut DIN 582

**finish:** painted red

**material:** alloy steel grade 80  
safety factor 4

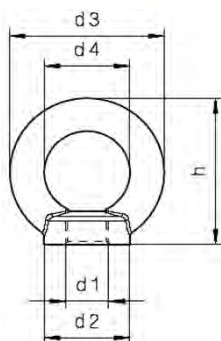

Kód Art. No.	d1 mm	d3 mm	d4 mm	h mm	nosnost kg		kg/100ks kg/100pcs	balení/ks bag/pcs	karton/ks carton/pcs
					WLL 0°	45°			
8582.06	M6	36	20	36	400	100	5,0	25	500
8582.08	M8	36	20	36	800	200	5,0	25	500
8582.10	M10	45	25	45	1000	250	9,0	20	250
8582.12	M12	54	30	53	1600	400	16,0	10	150
8582.14	M14	54	30	53	2000	500	21,0	10	100
8582.16	M16	63	35	62	4000	1000	24,0	10	80
8582.18	M18	63	35	62	5000	1250	24,0	5	80
8582.20	M20	72	40	71	6000	1500	36,0	5	50
8582.22	M22	72	40	71	7000	1750	36,0	5	50
8582.24	M24	90	50	90	8000	2000	76,0	1	30
8582.27	M27	90	50	90	9000	2250	76,0	1	30
8582.30	M30	108	60	109	12000	3000	135,0	1	15
8582.36	M36	126	70	128	16000	4000	208,0	1	10
8582.42	M42	144	80	147	24000	6000	311,0	1	5
8582.48	M48	165	90	168	32000	8000	502,0	1	3
8582.56	M56	185	98	190	45000	11250	715,0	1	3



# Vázací háky, komponenty tř.8

*Lifting hooks, components G80*

## Hák s okem DIN 689

**povrch:** galvanický zinkochromát (bílý) > 8µm  
**materiál:** ocel C15E, pevn.tř.4.8, Re 250-300MPa

**Hook with eye DIN 689**

**finish:** galvanized > 8µm  
**material:** forged steel C15

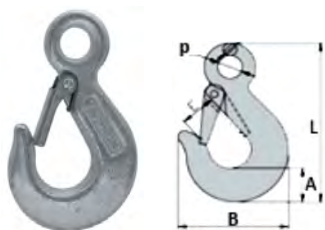

Kód Art. No.	p mm	B mm	E mm	A mm	L mm	nosnost WLL kg	kg/100ks kg/100pcs	balení/ks bag/pcs	karton/ks carton/pcs
8300.02	12	55	18	18	90	250	15,8	5	150
8300.05	16	75	24	24	120	500	33,0	5	75
8300.10	20	98	33	35	165	1000	87,7	1	30
8300.16	22	113	36	40	190	1600	126,0	1	20
8300.25	26	145	46	51	240	2500	255,0	1	10
8300.40	30	170	55	65	300	4000	560,0	1	5

## Hák vlečný

**povrch:** galvanický zinkochromát (bílý) > 8µm  
**materiál:** ocel C15E, pevn.tř.4.8, Re 250-300MPa

**Drag hook**

**finish:** galvanized > 8µm  
**material:** forged steel C15

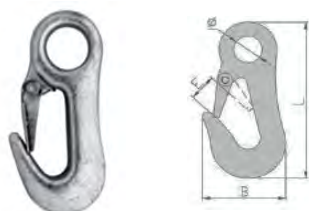

Kód Art. No.	ø mm	B mm	E mm	L mm	VVP kg	nosnost WLL kg	kg/100ks kg/100pcs	balení/ks bag/pcs	karton/ks carton/pcs
8304.05	18	44	16	90	3500	2000	16,0	10	150

VVP - maximální váha vlečeného vozidla

VVP - maximum weight of the towed vehicle

## Hák s okem - typ 320A

**povrch:** červeně lakovaný + pozinkovaná pojistka  
**materiál:** legovaná ocel 34Cr4, jak.70, Re 600-700MPa

**Eye Hoist hook - 320A**

**finish:** painted red  
**material:** alloy steel G70



Kód Art. No.	řetěz chain mm	ø mm	L mm	E mm	H mm	K mm	nosnost WLL kg	kg/100ks kg/100pcs	balení/ks bag/pcs
8720.07	5	16	98	22	17	72	750	22	1
8720.10	6	19	110	24	19	82	1000	28	1
8720.15	7	23	125	26	21	93	1500	43	1
8720.20	8	28	142	28	26	103	2000	58	1
8720.30	10	32	165	32	28	119	3000	86	1
8720.45	13	40	200	38	37	146	4500	175	1
8720.70	16	51	260	48	46	186	7000	340	1

## Hák otočný - typ 322A

**povrch:** červeně lakovaný + pozinkovaná pojistka  
**materiál:** legovaná ocel 34Cr4, jak.70, Re 600-700MPa

**Swivel hook - 322A**

**finish:** painted red  
**material:** alloy steel G70

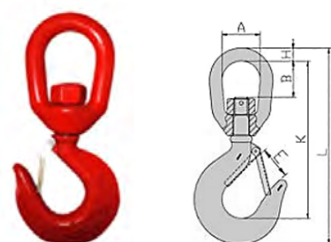

Kód Art. No.	A mm	B mm	E mm	H mm	K mm	L mm	nosnost WLL kg	kg/100ks kg/100pcs	balení/ks bag/pcs
8722.07	28	20	20	8	105	125	750	28	1
8722.10	31	23	23	9	113	140	1000	38	1
8722.15	38	30	23	12	128	167	1500	63	1
8722.20	43	33	24	16	150	192	2000	110	1
8722.30	43	33	26	16	163	208	3000	130	1
8722.45	49	39	34	18	188	242	4500	220	1
8722.70	64	53	42	25	245	318	7000	470	1

## Hák vázací s okem

**povrch:** červeně lakovaný + pozinkovaná pojistka  
**materiál:** dle ČSN EN 1677, legovaná ocel tř. 8  
**použití:** řetězové a lanové vazáky



### Eye sling hook

**finish:** painted red  
**material:** alloy steel grade 80  
**application:** chain and wire slings

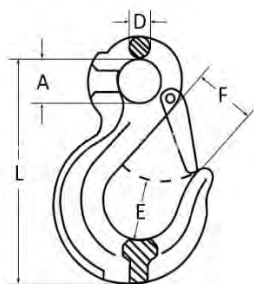

Kód Art. No.	řetěz chain mm	A mm	F mm	L mm	D mm	E mm	nosnost WLL kg	kg/1ks kg/1pcs	balení/ks bag/pcs
8830.06	6	20	24	108	9	21	1,12	0,26	1
8830.08	8	25	30	133	11	26	2,00	0,43	1
8830.10	10	38	34	167	15	39	3,15	0,98	1
8830.13	13	43	40	213	19	54	5,30	1,90	1
8830.16	16	50	47	255	23	64	8,00	3,15	1
8830.20	20	62	55	305	25	80	12,50	5,80	1
8830.22	22	64	70	348	32	80	15,00	8,70	1
8830.26	26	66	80	394	35	82	21,20	12,60	1

## Hák vázací s vydlicí

**povrch:** červeně lakovaný + pozinkovaná pojistka  
**materiál:** dle ČSN EN 1677, legovaná ocel tř. 8  
**použití:** řetězové a lanové vazáky



### Clevis sling hook

**finish:** painted red  
**material:** alloy steel grade 80  
**application:** chain and wire slings

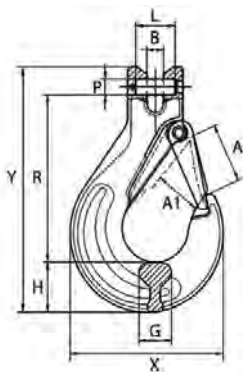

Kód Art. No.	řetěz chain mm	B mm	A1 mm	R mm	H mm	P x L mm	nosnost WLL t	kg/1ks kg/1pcs	balení/ks bag/pcs
8831.06	6	7,5	25	74	25	7,5 x 20	1,12	0,33	1
8831.08	8	9,0	26	85	33	9 x 23	2,00	0,53	1
8831.10	10	12,5	33	104	38	13 x 31	3,15	1,00	1
8831.13	13	17,0	44	126	43	16 x 42	5,30	1,72	1
8831.16	16	21,5	54	147	55	20 x 52	8,00	3,82	1
8831.20	20	24,0	62	185	60	24 x 62	12,50	6,20	1
8831.22	22	27,0	72	213	65		15,00	9,80	1

## Hák zkracovací s vydlicí

**povrch:** červeně lakovaný  
**materiál:** dle ČSN EN 1677, legovaná ocel tř. 8  
**použití:** řetězové vazáky



### Clevis grab hook

**finish:** painted red  
**material:** alloy steel grade 80  
**application:** chain slings

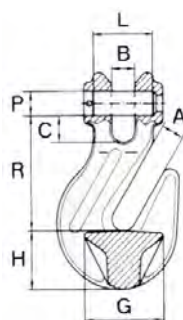

Kód Art. No.	řetěz chain mm	B mm	A mm	R mm	G   H mm	P x L mm	nosnost WLL t	kg/1ks kg/1pcs	balení/ks bag/pcs
8851.06	6	8	8	74	25 19	7,5 x 20	1,12	0,16	1
8851.08	8	10	10	50	30 24	9 x 23	2,00	0,30	1
8851.10	10	12	13	72	44 31	13 x 31	3,15	0,76	1
8851.13	13	15	16	88	53 38	16 x 42	5,30	1,60	1
8851.16	16	19	20	111	64 60	20 x 52	8,00	2,80	1
8851.20	20	24	24	130	85 65	24 x 62	12,50	4,60	1

## Oko závěsné A343

**povrch:** červeně lakovaný

**materiál:** dle ČSN EN 1677, legovaná ocel tř. 8

**použití:** lanové a řetězové vazáky



### Master link A343

**finish:** painted red

**material:** alloy steel grade 80

**application:** chain and wire rope slings

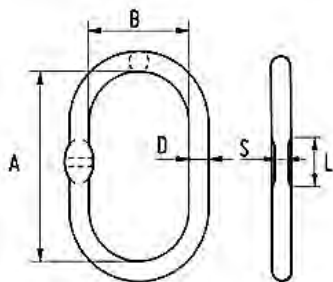

Kód Art. No.	použití Ø řetězu		A mm	B mm	D mm	S mm	nosn./WLL [kg] 0°-45°		kg/1ks kg/1pcs
	1pr./leg	2pr./leg					1pr./leg	2pr./legs	
8800.06	6	6	110	60	13	6,0	1600		0,41
8800.08	8	7	110	60	16	7,6	2120		0,83
8800.10	10	8	135	75	18	7,6	3150		1,47
8800.13	13	10	160	90	22	8,4	5300		2,72
8800.16	16	13	180	100	26	13,5	8000		3,96
8800.20	20	18	260	140	36	16,5	12500		8,97
8800.22	22	20	300	160	40	-	15000		12,83
8800.26	26	22	340	180	45	-	21200		16,57

## Oko závěsné A346

**povrch:** červeně lakovaný

**materiál:** dle ČSN EN 1677, legovaná ocel tř. 8

**použití:** lanové a řetězové vazáky



### Master link A346

**finish:** painted red

**material:** alloy steel grade 80

**application:** chain and wire rope slings

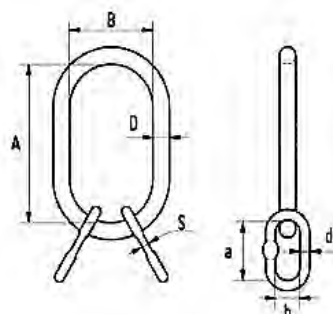

Kód Art. No.	A	B	D	a	b	d	S	nosnost WLL / kg	kg/1ks kg/1pcs
	chain mm	mm	mm	mm	mm	mm	mm		
8804.06	135	75	18	54	25	14	7,6	1600	1,27
8804.08	160	90	22	70	34	16	7,6	2120	2,19
8804.10	180	100	28	85	40	18	8,4	3150	3,81
8804.13	200	110	32	115	50	22	13,5	5300	6,08
8804.16	260	140	38	140	65	28	16,5	8000	11,38
8804.20	350	190	50	180	100	32	20,5	12500	23,83
8804.22	350	190	50	180	100	38	26,0	15000	27,14
8804.26	400	200	56	180	100	40	30,0	21200	35,14

## Identifikační štítek

Je součástí každého vazacího řetězu a obsahuje tyto informace:

třída oceli, jmenovitá velikost řetězu, počet pramenů, nosnost (při daném úhlu sklonu), datum výroby, záznam servisní prohlídky



### Identification tag

Is part of every chain sling and contains following information:

steel grade, nominal size of chain, number of legs, WLL, date of manufacture, inspection chart

## Článek spojovací C

**povrch:** červeně lakovaný  
**materiál:** dle ČSN EN 1677, legovaná ocel tř. 8  
**použití:** lanové a řetězové vazáky



### Connecting link C

**finish:** painted red  
**material:** alloy steel grade 80  
**application:** chain and wire rope slings

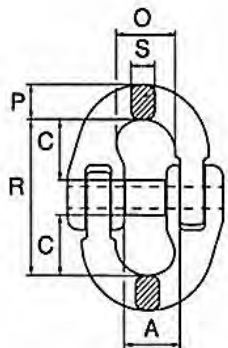

Kód Art. No.	řetěz chain mm	A mm	C mm	O mm	R mm	P mm	S mm	nosnost WLL / kg	kg/1ks kg/1pcs
8825.06	6	17,8	18,0	16,5	43,0	7,2	6,8	1120	0,08
8825.08	8	23,8	25,5	23,5	62,0	11,5	10,0	2000	0,16
8825.10	10	28,0	30,0	27,5	72,0	12,6	12,6	3150	0,30
8825.13	13	34,3	36,0	33,3	87,3	19,0	16,7	5300	0,70
8825.16	16	36,0	40,5	39,5	103,0	20,6	20,6	8000	1,25
8825.20	20	44,0	48,0	47,0	116,0	23,0	23,0	12500	1,95
8825.22	22	49,0	51,0	55,0	133,0	26,5	26,5	15000	3,20
8825.26	26	60,0	60,0	66,0	148,0	31,5	31,5	21200	4,50

## Článek Omega

**povrch:** červeně lakovaný  
**materiál:** dle ČSN EN 1677, legovaná ocel tř. 8  
**použití:** lanové a řetězové vazáky



### Omega link

**finish:** painted red  
**material:** alloy steel grade 80  
**application:** chain and wire rope slings

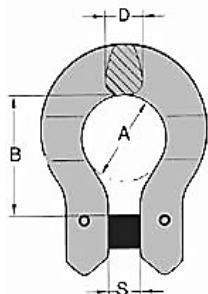

Kód Art. No.	řetěz chain mm	A mm	B mm	D mm	S mm	nosnost WLL / kg	kg/1ks kg/1pcs
8828.06	6	20	26	9	9	1120	0,10
8828.08	8	23	34	12	12	2000	0,23
8828.10	10	31	40	16	13	3150	0,42
8828.13	13	40	55	20	17	5300	0,95
8828.16	16	48	66	25	19	8000	1,36
8828.20	20	58	78	30	23	12500	2,12

## Hák lesnický s vydlicí

**povrch:** červeně lakovaný  
**materiál:** dle ČSN EN 1677, legovaná ocel tř. 8  
**použití:** lanové a řetězové vazáky



### Clevis Forest hook

**finish:** painted red  
**material:** alloy steel grade 80  
**application:** chain and wire rope slings

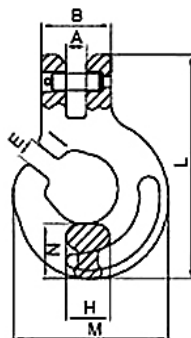

Kód Art. No.	řetěz chain mm	A mm	B mm	E mm	L mm	N mm	M mm	nosnost WLL / kg	kg/1ks kg/1pcs
8860.08	8	9,5	35	10	95	22	73,0	2000	0,41
8860.10	10	13	44	13	137	33	97,0	3150	0,92
8860.13	13	16	53	16	165	40	119,0	5300	1,75







Kladky

*Pulley and Snatch block*

## Kladka s nylonovou cívkou

**povrch:** galvanický zinkochromát (bílý) > 8µm

**materiál:** pouzdro zinková slitina, cívka nylon

**Rigid pulley with nylon spool**

**finish:** galvanized > 8µm

**material:** zinc alloy, nylon pulley

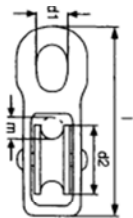

Kód Art. No.	m mm	d1 mm	d2 mm	l mm	nosnost WLL kg	kg/100ks kg/100pcs	balení/ks bag/pcs	karton/ks carton/pcs
3641.05	5	10	15	50	80	2,0	20	1 000
3641.06	6	11	20	60	100	3,6	20	600
3641.07	7	12	25	70	120	5,3	10	400
3641.08	8	13	30	80	160	8,1	10	250
3641.09	9	16	40	90	200	13,3	5	150
3641.12	12	18	50	110	250	17,6	5	100
3641.15	15	20	65	135	300	41,5	1	50

## Kladka dvojitá s nylonovou cívkou

**povrch:** galvanický zinkochromát (bílý) > 8µm

**materiál:** pouzdro zinková slitina, cívka nylon

**Double rigid pulley with nylon spool**

**finish:** galvanized > 8µm

**material:** zinc alloy, nylon pulley

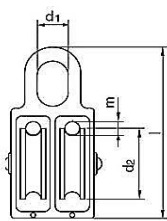

Kód Art. No.	m mm	d1 mm	d2 mm	l mm	nosnost WLL kg	kg/100ks kg/100pcs	balení/ks bag/pcs	karton/ks carton/pcs
3642.05	5	10	15	50	80	3,4	10	600
3642.06	6	11	20	60	100	5,8	10	300
3642.07	7	12	25	70	120	7,3	10	200
3642.08	8	13	30	80	160	11,7	5	150
3642.09	9	16	40	90	200	17,1	5	100
3642.12	12	18	50	110	250	29,0	1	60

## Kladka s nylonovou cívkou - otočná

**povrch:** galvanický zinkochromát (bílý) > 8µm

**materiál:** pouzdro zinková slitina, cívka nylon

**Swivel pulley with nylon spool**

**finish:** galvanized > 8µm

**material:** zinc alloy, nylon pulley

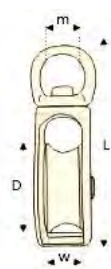

Kód Art. No.	w mm	m mm	D mm	L mm	nosnost WLL kg	kg/100ks kg/100pcs	balení/ks bag/pcs	karton/ks carton/pcs
3645.05	5	10	15	50	60	2,0	10	1 000
3645.06	6	11	20	60	80	3,6	10	600
3645.07	7	12	25	70	100	5,3	10	400
3645.08	8	13	30	80	140	8,1	5	250
3645.09	9	16	40	90	160	13,3	5	150
3645.12	12	18	50	110	200	17,6	5	100

## Kladka se šroubem - nylon

**povrch:** galvanický zinkochromát (bílý) > 8µm

**materiál:** pouzdro ocel, cívka nylon

**Pulley with screw**

**finish:** galvanized > 8µm

**material:** steel and nylon

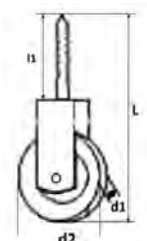

Kód Art. No.	Ø mm	d1 mm	d2 mm	l1 mm	L mm	kg/100ks kg/100pcs	balení/ks bag/pcs	karton/ks carton/pcs
3654.08	8	10	31	38	83	4,0	20	500
3654.10	10	12	50	38	103	5,8	10	250

## Kladka s kovovou cívkou

**povrch:** poniklováno a pomosazeno  
**materiál:** pouzdro zinková slitina, cívka ocel

### Rigid pulley with steel spool

**finish:** nickel and brass plated  
**material:** zinc alloy, steel pulley

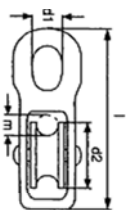

Kód Art. No.	m mm	d1 mm	d2 mm	l mm	nosnost WLL kg	kg/100ks kg/100pcs	balení/ks bag/pcs	karton/ks carton/pcs
3643.05	5	4	15	36	50	1,5	20	1 000
3643.06	6	5	20	42	60	2,3	20	600
3643.07	7	6	25	52	80	4,2	10	400
3643.08	8	10	30	72	120	7,1	10	250
3643.09	9	10	40	76	120	8,6	5	150
3643.10	10	13	50	97	150	16,8	5	100

## Kladka dvojitá s kovovou cívkou

**povrch:** poniklováno a pomosazeno  
**materiál:** pouzdro zinková slitina, cívka ocel

### Double rigid pulley

**finish:** yellow galvanized > 10µm  
**material:** zinc alloy, steel pulley

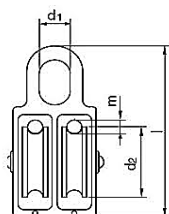

Kód Art. No.	m mm	d1 mm	d2 mm	l mm	nosnost WLL kg	kg/100ks kg/100pcs	balení/ks bag/pcs	karton/ks carton/pcs
3644.05	5	4	15	36	50	1,5	10	1 000
3644.06	6	5	20	42	60	2,3	10	600
3644.07	7	6	25	52	80	4,2	10	400
3644.08	8	10	30	72	120	7,1	5	250
3644.09	9	10	40	76	120	8,6	5	150
3644.10	10	13	50	97	150	16,8	5	100

## Kladka dvojitá s kovovou cívkou - otočná

**povrch:** poniklováno a pomosazeno  
**materiál:** pouzdro zinková slitina, cívka ocel

### Double rigid pulley swivel

**finish:** yellow galvanized > 10µm  
**material:** zinc alloy, steel pulley

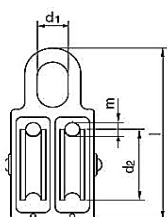

Kód Art. No.	m mm	d1 mm	d2 mm	l mm	nosnost WLL kg	kg/100ks kg/100pcs	balení/ks bag/pcs	karton/ks carton/pcs
3646.05	5	10	15	50	50	1,5	10	1 000
3646.06	6	11	20	60	60	2,3	10	600
3646.07	7	12	25	70	80	4,2	10	400
3646.08	8	13	32	80	120	7,1	5	250
3646.09	9	16	40	90	120	8,6	5	150
3646.10	10	18	50	100	150	16,8	5	100

## Kladka se šroubem - litinová

**povrch:** galvanický zinkochromát (bílý) > 8µm  
**materiál:** pouzdro ocel, cívka zinková slitina

### Pulley with screw

**finish:** galvanized > 8µm  
**material:** steel and zinc alloy pulley

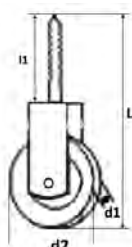

Kód Art. No.	Ø mm	d1 mm	d2 mm	l1 mm	L mm	kg/100ks kg/100pcs	balení/ks bag/pcs	karton/ks carton/pcs
3653.08	8	10	31	38	83	4,5	20	500
3653.10	10	12	50	38	103	6,0	10	250

## Kladka stavební

**povrch:** práškový lak

**materiál:** ocel třídy 24

**Použití:** stavebnictví - pro ocelová i textilní lana

**Gin block**

**finish:** painted

**material:** steel grade 24

**application:** for textile and steel ropes

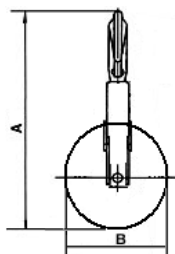

### OKO

**EYE**

Kód Art. No.	Ø mm	A mm	B mm	nosnost WLL / kg	kg/1ks kg/1pcs	balení/ks bag/pcs	karton/ks carton/pcs
3668.22	16 - 22	350	200	450	4,5	1	5
3668.26	22 - 26	400	250	450	5,3	1	4

### HÁK

**HOOK**

Kód Art. No.	Ø mm	A mm	B mm	nosnost WLL / kg	kg/1ks kg/1pcs	balení/ks bag/pcs	karton/ks carton/pcs
3669.22	16 - 22	350	200	450	4,9	1	5
3669.26	22 - 26	400	250	450	5,7	1	4

## Kladka s odklápěcí bočnicí - hák

**povrch:** práškový lak

**materiál:** zušlechtěná ocel, hák a cívka legovaná ocel

**Použití:** stavebnictví - pro ocelová i textilní lana

**Snatch block open side - hook**

**finish:** painted

**material:** drop forged

**application:** for textile and steel ropes

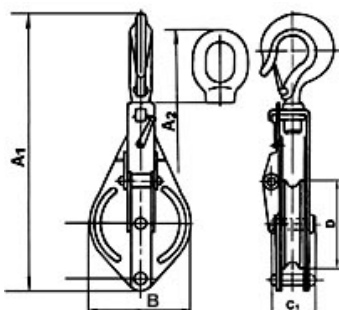

Kód Art. No.	A1 mm	B mm	C1 mm	D mm	lano rope	nosnost WLL kg	kg/1ks kg/1pcs	balení/ks bag/pcs
3682.08	268	87	50	75	8-10	500	1,4	1
3682.10	312	112	55	100	12-14	1000	2,4	1
3682.13	405	140	63	125	16-18	1500	3,8	1
3682.16	443	168	101	150	18-20	2000	6,0	1
3682.19	498	204	107	180	20-22	3000	10,3	1

## Kladka s odklápěcí bočnicí - oko

**povrch:** práškový lak

**materiál:** zušlechtěná ocel, oko a cívka legovaná ocel

**Použití:** stavebnictví - pro ocelová i textilní lana

**Snatch block open side - eye**

**finish:** painted

**material:** drop forged

**application:** for textile and steel ropes

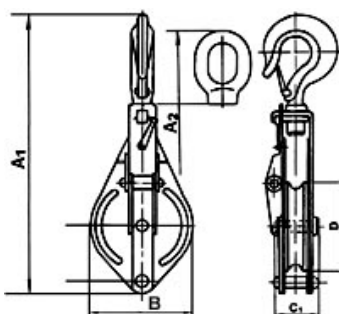

Kód Art. No.	A1 mm	B mm	C1 mm	D mm	lano rope	nosnost WLL kg	kg/1ks kg/1pcs	balení/ks bag/pcs
3683.08	290	87	50	75	8-10	500	1,6	1
3683.10	285	112	55	100	12-14	1000	2,5	1
3683.13	344	140	63	125	16-18	1500	4,0	1
3683.16	417	168	101	150	18-20	2000	6,3	1

## Kladka zednická s okem

**Trowel block with eye**

**povrch:** práškový lak

**materiál:** zušlechtěná ocel, hák a cívka legovaná ocel

**Použití:** stavebnictví - pro ocelová i textilní lana

**finish:** painted

**material:** drop forged

**application:** for textile and steel ropes

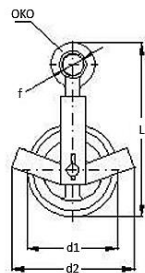

Kód Art. No.	Ø mm	d1 mm	d2 mm	nosnost WLL / kg	kg/1ks kg/1pcs	balení/ks bag/pcs	karton/ks carton/pcs
3688.125	10 - 16	125	200	500	2,0	1	10
3688.150	16 - 22	150	250	500	3,3	1	5

## Kladka zednická s hákem

**Trowel block with hook**

**povrch:** práškový lak

**materiál:** zušlechtěná ocel, hák a cívka legovaná ocel

**Použití:** stavebnictví - pro ocelová i textilní lana

**finish:** painted

**material:** drop forged

**application:** for textile and steel ropes

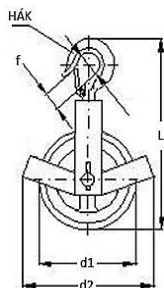

Kód Art. No.	Ø mm	d1 mm	d2 mm	nosnost WLL / kg	kg/1ks kg/1pcs	balení/ks bag/pcs	karton/ks carton/pcs
3689.125	10 - 16	125	200	500	2,1	1	10
3689.150	16 - 22	150	250	500	3,4	1	5





# Kotevní prvky

---

## *Anchors*

## Hmoždinka univerzální

materiál: nylon

Universal dowels

material: nylon



Kód Art. No.	Ø mm	L mm	vrut screw	kg/100ks kg/100pcs	balení/ks bag/pcs	karton/ks carton/pcs
5005.0525	5	25	4 x 30	0,05	150	6 750
5005.0630	6	30	4,5 x 50	0,07	100	4 500
5005.0840	8	40	5 x 50	0,15	100	2 400
5005.1050	10	50	6 x 60	0,29	50	1 200
5005.1260	12	60	10 x 70	0,44	25	600
5005.1470	14	70	12 x 80	0,64	20	480

## Hmoždinka zatloukací

materiál: nylon + ocel pozinkovaná

Plugs Impact

material: nylon + steel galvanized



5010 válcová



5011 zápuštná



Kód Art. No.	Ø mm	L mm	Kód Art. No.	Ø mm	L mm	kg/100ks kg/100pcs	balení/ks bag/pcs	karton/ks carton/pcs
5010.063	6	35	5011.063	6	35	0,38	150	1 200
5010.064	6	40	5011.064	6	40	0,42	100	1 200
5010.065	6	45	5011.065	6	45	0,50	100	1 200
5010.066	6	60	5011.066	6	60	0,57	100	1 200
5010.085	8	45	5011.085	8	45	0,84	100	800
5010.086	8	60	5011.086	8	60	1,06	100	600
5010.088	8	80	5011.088	8	80	1,29	100	600
5010.090	8	100	5011.090	8	100	1,57	50	600
5010.092	8	120	5011.092	8	120	1,89	50	400
5010.094	8	140	5011.094	8	140	2,06	50	300

11

## Hmoždinky do sádkartonu - TAPLA

materiál: nylon

Easy drive plug - TAPLA

material: nylon



Kód Art. No.	délka mm	Ø mm	vrut screw	kg/100ks kg/100pcs	balení/ks bag/pcs	karton/ks carton/pcs
5013.MFJ	32	12	4,5 x 32		100	2 400

materiál: zinková slitina ZAMAK

material: Zamak



Kód Art. No.	délka mm	Ø mm	vrut screw	kg/100ks kg/100pcs	balení/ks bag/pcs	karton/ks carton/pcs
5014.MJP	37	12	4,2 x 35		100	2 400



## Hmoždinky do dutých materiálů

materiál: nylon

**Toggle plug**

material: nylon



Kód Art. No.	délka mm	Ø mm	vrut screw	kg/100ks kg/100pcs	balení/ks bag/pcs	karton/ks carton/pcs
5015.140	40	10	4 x 50		100	600
5015.147	47	10	4 x 60		100	600

## Hmoždinka lešenářská

materiál: PA 6 (nylon)

**Scaffolding plug**

material: polyamid 6

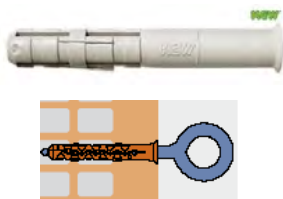

Kód Art. No.	délka mm	Ø mm	délka vrutu mm	Ø vrutu mm	zatižení* WLL kN	kg/100ks kg/100pcs	balení/ks bag/pcs	karton/ks carton/pcs
5020.070	70	14	90 - 450	12,0	4,0	0,65	100	600
5020.100	100	14	120 - 450	12,0	4,5	0,80	100	600

\*povolené tahové zatižení - beton C20/25, bezp. faktor 3

## Skoba s límcem a hmoždinkou

povrch: galvanický zinkochromát > 8µm

materiál: ocel S235JR, pevn.tř.4.6, Re 235MPa



**Squarehook with plug**

finish: galvanized > 8µm

material: carbon steel St 37-2

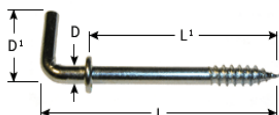

Kód Art. No.	L mm	L1 mm	mm	D mm	D1 mm	kg/100ks kg/100pcs	balení/ks bag/pcs	karton/ks carton/pcs
5030.064	52	40	6 x 35	3,4	13	0,45	100	3 000
5030.085	67	55	8 x 50	4,0	14	0,95	100	2 000
5030.106	78	65	10 x 60	4,8	15	1,65	50	1 000

## Hák s límcem a hmoždinkou

povrch: galvanický zinkochromát > 8µm

materiál: ocel S235JR, pevn.tř.4.6, Re 235MPa



**Cuphook with plug**

finish: galvanized > 8µm

material: carbon steel St 37-2

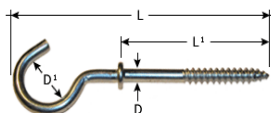

Kód Art. No.	L mm	L1 mm	mm	D mm	D1 mm	kg/100ks kg/100pcs	balení/ks bag/pcs	karton/ks carton/pcs
5031.064	70	40	6 x 35	3,4	13	0,70	100	3 000
5031.085	88	55	8 x 50	4,0	14	1,20	100	2 000
5031.106	100	65	10 x 60	4,8	15	1,80	50	1 000

## Oko s límcem a hmoždinkou

povrch: galvanický zinkochromát > 8µm

materiál: ocel S235JR, pevn.tř.4.6, Re 235MPa



**Eyehook with plug**

finish: galvanized > 8µm

material: carbon steel St 37-2

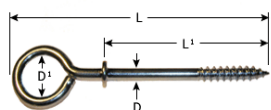

Kód Art. No.	L mm	L1 mm	mm	D mm	D1 mm	kg/100ks kg/100pcs	balení/ks bag/pcs	karton/ks carton/pcs
5032.064	70	40	6 x 35	3,4	13	0,80	100	2 500
5032.085	88	55	8 x 50	4,0	14	1,45	50	1 500
5032.106	100	65	10 x 60	4,8	15	2,30	50	1 000

## Kotva rozpěrná s hákem

**povrch:** galvanický zinkochromát > 8µm  
**materiál:** ocel S235JR, pevn.tř.4.6, Re 235MPa

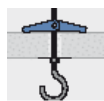
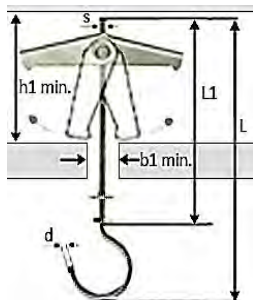

**Spring toggle with hook**

**finish:** galvanized > 8µm

**material:** carbon steel St 37-2

Kód Art. No.	s mm	L mm	L1 mm	h1 mm	b1 mm	d mm	kg/100ks kg/100pcs	balení/ks bag/pcs	karton/ks carton/pcs
5040.409	M4	95	65	35	12	3,50	2,45	20	500
5040.510	M5	100	70	35	15	4,40	3,35	20	300
5040.613	M6	130	95	40	18	5,20	4,60	10	300

## Kotva rozpěrná s maticí

**povrch:** galvanický zinkochromát > 8µm  
**materiál:** ocel S235JR, pevn.tř.4.6, Re 235MPa

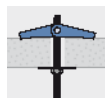
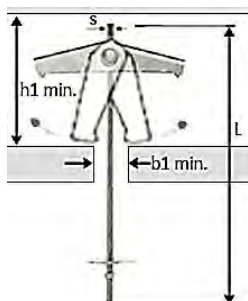

**Spring toggle with nut**

**finish:** galvanized > 8µm

**material:** carbon steel St 37-2

Kód Art. No.	s mm	L mm	h1 mm	b1 mm			kg/100ks kg/100pcs	balení/ks bag/pcs	karton/ks carton/pcs
5041.409	M4	90	35	12			1,80	20	500
5041.510	M5	100	35	15			2,80	20	300
5041.610	M6	100	40	18			3,90	10	300

## Kotva sklopná s hákem

**povrch:** galvanický zinkochromát > 8µm  
**materiál:** ocel S235JR, pevn.tř.4.6, Re 235MPa

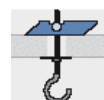
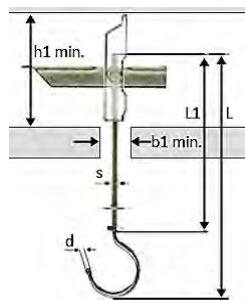

**Spring toggle with hook**

**finish:** galvanized > 8µm

**material:** carbon steel St 37-2

Kód Art. No.	s mm	L mm	l1 mm	h1 mm	b1 mm	d mm	kg/100ks kg/100pcs	balení/ks bag/pcs	karton/ks carton/pcs
5043.409	M4	95	65	70	12	3,6	3,60	20	300
5043.510	M5	100	70	70	12	4,4	4,20	20	300
5043.613	M6	130	95	80	16	5,2	5,80	10	200

## Kotva sklopná s maticí

**povrch:** galvanický zinkochromát > 8µm  
**materiál:** ocel S235JR, pevn.tř.4.6, Re 235MPa

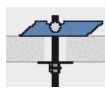
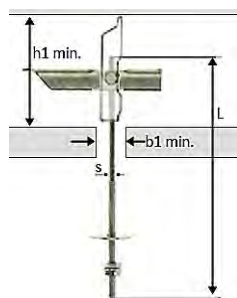

**Spring toggle with nut**

**finish:** galvanized > 8µm

**material:** carbon steel St 37-2

Kód Art. No.	s mm	L mm	h1 mm	b1 mm			kg/100ks kg/100pcs	balení/ks bag/pcs	karton/ks carton/pcs
5044.409	M4	100	70	12			2,70	20	300
5044.510	M5	100	70	12			3,60	20	300
5044.610	M6	100	80	16			5,00	10	200

## Páska stahovací

materiál: polyamid 6.6 (nylon), odolnost dle UL94V-2L

**Cable tie**

material: Nylon (polyamide 6.6)



barva: **PŘÍRODNÍ**

colour: **NATURAL**

Kód Art. No.	L mm	W mm	odolnost / kg resistance / kg	max. Ø svazku max. bundle / mm	kg/100ks kg/100pcs	balení/ks bag/pcs	karton/ks carton/pcs
5B.25.080	80	2,5	8,2	17	0,03	100	1 000
5B.25.100	100	2,5	8,2	25	0,03	100	1 000
5B.25.140	140	2,5	8,2	38	0,04	100	1 000
5B.25.160	160	2,5	8,2	45	0,05	100	1 000
5B.25.200	200	2,5	8,2	50	0,06	100	1 000
5B.36.140	140	3,6	18,3	37	0,07	100	1 000
5B.36.200	200	3,6	18,3	57	0,09	100	1 000
5B.36.300	300	3,6	18,3	87	0,14	100	1 000
5B.36.370	370	3,6	18,3	110	0,18	100	1 000
5B.48.120	120	4,8	22,4	29	0,08	100	1 000
5B.48.160	160	4,8	22,4	43	0,10	100	1 000
5B.48.200	200	4,8	22,4	56	0,13	100	1 000
5B.48.250	250	4,8	22,4	72	0,16	100	1 000
5B.48.290	290	4,8	22,4	83	0,19	100	1 000
5B.48.370	370	4,8	22,4	109	0,25	100	1 000
5B.48.430	430	4,8	22,4	129	0,30	100	1 000
5B.76.200	200	7,6	56,1	54	0,26	100	500
5B.76.290	290	7,6	56,1	82	0,37	100	500
5B.76.370	370	7,6	56,1	108	0,44	100	500
5B.76.450	450	7,6	56,1	130	0,52	100	500
5B.76.540	540	7,6	56,1	162	0,72	100	500
5B.88.770	770	8,8	81,5	233	1,10	50	500

barva: **ČERNÁ**

colour: **BLACK**

Kód Art. No.	L mm	W mm	odolnost / kg resistance / kg	max. Ø svazku max. bundle / mm	kg/100ks kg/100pcs	balení/ks bag/pcs	karton/ks carton/pcs
5C.25.080	80	2,5	8,2	17	0,03	100	1 000
5C.25.100	100	2,5	8,2	25	0,03	100	1 000
5C.25.140	140	2,5	8,2	38	0,04	100	1 000
5C.25.160	160	2,5	8,2	45	0,05	100	1 000
5C.25.200	200	2,5	8,2	50	0,06	100	1 000
5C.36.140	140	3,6	18,3	37	0,07	100	1 000
5C.36.200	200	3,6	18,3	57	0,09	100	1 000
5C.36.300	300	3,6	18,3	87	0,14	100	1 000
5C.36.370	370	3,6	18,3	110	0,18	100	1 000
5C.48.120	120	4,8	22,4	29	0,08	100	1 000
5C.48.160	160	4,8	22,4	43	0,10	100	1 000
5C.48.200	200	4,8	22,4	56	0,13	100	1 000
5C.48.250	250	4,8	22,4	72	0,16	100	1 000
5C.48.290	290	4,8	22,4	83	0,19	100	1 000
5C.48.370	370	4,8	22,4	109	0,25	100	1 000
5C.48.430	430	4,8	22,4	129	0,30	100	1 000
5C.76.200	200	7,6	56,1	54	0,26	100	500
5C.76.290	290	7,6	56,1	82	0,37	100	500
5C.76.370	370	7,6	56,1	108	0,44	100	500
5C.76.450	450	7,6	56,1	130	0,52	100	500
5C.76.540	540	7,6	56,1	162	0,72	100	500
5C.88.770	770	8,8	81,5	233	1,10	50	500

## Přichytka na kabel - zatloukací

**povrch:** galvanický zinkochromát > 8µm

**materiál:** polyamid 6.6 (nylon) s ocelovým hřebíkem

**Cable clip**

**finish:** galvanized > 8µm

**material:** nylon (polyamide 6.6) with steel nail



Kód Art. No.	A mm	B mm	rozsah range mm	hřebík nail mm	kg/100ks kg/100pcs	balení/ks bag/pcs	karton/ks carton/pcs
5021.057	5	7,5	5 - 7	2 x 23	0,80	100	2 500
5021.071	7	11,0	7 - 12	2 x 23	1,45	50	1 500
5021.114	10	12,4	10 - 14	2 x 30	2,30	50	1 000

## Hmoždinka pro stahovací pásy

**materiál:** polyamid 6.6 (nylon), odolnost dle UL94V-2L

**Cable tie plug**

**material:** Nylon (polyamide 6.6)

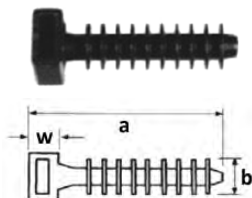

Kód Art. No.	a mm	b mm	max. paska max. tie mm	barva colour	kg/100ks kg/100pcs	balení/ks bag/pcs	karton/ks carton/pcs
5H9B.08	40	8	9,9	bílá / white	0,17	100	5 000
5H9B.10	43	10	9,9	bílá / white	0,24	100	1 200
5H9C.08	40	8	9,9	černá / black	0,17	100	5 000
5H9C.10	43	10	9,9	černá / black	0,24	100	1 200

## Kombi šroub - Torx

**povrch:** galvanický zinkochromát > 10µm

**materiál:** ocel S275JR, pevn. tř. 5.6, Re 275MPa

**Hanger bolt**

**finish:** galvanized > 10µm

**material:** forged steel St 44-2



Kód Art. No.	Ø D mm	L mm	LM mm	LV mm	SW mm	 mm	kg/100ks kg/100pcs	balení/ks bag/pcs	karton/ks carton/pcs
5130.065	M6	50	20	25	4	8	0,66	100	3 000
5130.066	M6	60	25	30	4	8	0,91	100	2 000
5130.068	M6	80	30	40	4	8	1,23	100	2 000
5130.086	M8	60	25	30	6	10	1,31	100	2 000
5130.087	M8	70	30	35	6	10	1,64	100	1 000
5130.088	M8	80	30	40	6	10	1,84	100	1 000
5130.089	M8	90	40	40	6	10	2,12	100	1 000
5130.090	M8	100	40	50	6	10	2,45	100	1 000
5130.092	M8	120	50	50	6	10	2,95	100	1 000
5130.094	M8	140	50	50	6	10	3,51	50	500
5130.096	M8	160	50	50	6	10	4,14	50	500
5130.106	M10	60	20	30	8	12	2,20	50	500
5130.108	M10	80	30	40	8	12	3,03	50	500
5130.110	M10	100	40	50	8	12	3,88	50	500
5130.112	M10	120	50	60	8	12	4,65	50	500
5130.114	M10	140	50	60	8	12	5,60	50	300
5130.116	M10	160	50	60	8	12	6,54	50	300
5130.118	M10	180	50	60	8	12	7,38	50	300
5130.119	M10	200	50	60	8	12	8,46	50	300
5130.122	M12	120	50	60	10	14	13,32	25	150
5130.126	M12	160	50	60	10	14	18,92	25	100
5130.129	M12	200	50	60	10	14	24,72	25	100

## Objímka jednošroubová

**povrch:** galvanický zinkochromát

**materiál:** SBR/EPDM, tvrdost pryžové vložky 45° ± 5 Shore A?/ 15 s  
použití v rozmezí teplot -40 °C až +110 °C

**Single screw clamp**

**finish:** galvanized > 10µm  
**material:** SBR/EPDM



Kód Art. No.	rozsah potrubí		D1	L	K x T	Šroub	kg/100ks kg/100pcs	balení/ks bag/pcs	karton/ks carton/pcs
	mm	inch	mm	mm	mm	mm			
5101.10	10-12	1/8"	M8	41	20x1	M5x25	2,90	25	100
5101.12	12-16	1/4"	M8	43	20x1	M5x25	3,30	25	100
5101.17	17-19	3/8"	M8	46	20x1	M5x25	3,70	25	100
5101.20	20-24	1/2"	M8	50	20x1	M5x25	4,00	20	100
5101.25	25-30	3/4"	M8	58	20x1	M5x25	4,70	20	100
5101.31	31-38	1"	M8	65	20x1	M5x25	5,20	20	100
5101.40	40-46	1 1/4"	M8	70	20x1	M5x25	6,00	20	100
5101.48	48-53	1 1/2"	M8	80	20x1	M5x25	6,90	10	50
5101.60	60-64	2"	M8	102	20x1	M5x25	8,30	10	50

## Objímka dvoušroubová

**povrch:** galvanický zinkochromát

**materiál:** SBR/EPDM, tvrdost pryžové vložky 45° ± 5 Shore A?/ 15 s  
použití v rozmezí teplot -40 °C až +110 °C

**Double screw clamp**

**finish:** galvanized > 10µm  
**material:** SBR/EPDM

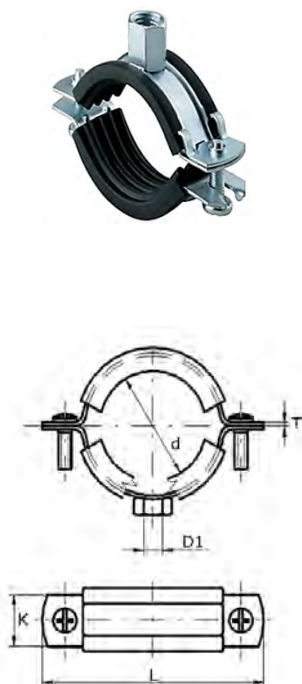

Kód Art. No.	rozsah potrubí		D1	L	K x T	Šroub	kg/100ks kg/100pcs	balení/ks bag/pcs	karton/ks carton/pcs
	mm	inch	mm	mm	mm	mm			
5102.012	12-16	1/4"	M8	60	20x1,25	M5x20	4,60	25	100
5102.017	17-19	3/8"	M8	60	20x1,25	M5x20	4,60	25	100
5102.020	20-24	1/2"	M8	65	20x1,25	M5x20	5,40	25	100
5102.025	25-30	3/4"	M8	70	20x1,25	M5x20	5,50	25	100
5102.031	31-38	1"	M8	78	20x1,25	M5x20	6,20	25	100
5102.040	40-46	1 1/4"	M8	88	20x1,25	M5x20	7,50	25	100
5102.048	48-53	1 1/2"	M8	96	20x1,25	M5x20	8,00	25	100
5102.054	54-59	-	M8/M10	105	20x1,25	M6x20	9,40	25	100
5102.060	60-64	2"	M8/M10	110	20x1,5	M6x20	9,60	25	100
5102.067	67-71	-	M8/M10	120	20x1,5	M6x20	10,30	10	50
5102.072	72-78	2 1/2"	M8/M10	130	25x1,5	M6x20	15,00	10	50
5102.081	81-86	-	M8/M10	140	25x1,5	M6x25	17,00	10	50
5102.087	87-92	3"	M8/M10	145	25x1,5	M6x25	18,00	10	50
5102.095	95-103	-	M8/M10	150	25x1,5	M6x30	18,90	10	50
5102.102	102-116	4"	M8/M10	170	25x2,0	M6x30	23,10	10	50
5102.121	121-127	-	M8/M10	195	25x2,5	M8x30	34,00	5	25
5102.133	133-141	5"	M8/M10	200	25x2,5	M8x30	37,40	5	25
5102.159	159-168	6"	M8/M10	230	25x2,5	M8x30	41,20	5	25
5102.204	204-210	-	M8/M10	285	25x2,5	M8x30	53,10	1	12
5102.210	210-219	8"	M8/M10	285	25x2,5	M8x30	53,10	1	12

## Objímka jednobodová "A"

**povrch:** galvanický zinkochromát

**materiál:** ocel dle EN DD11; pevn.tř. 5.6; Rm 320MPa

**Pipeline clip single**

**finish:** galvanized > 10µm

**material:** carbon steel

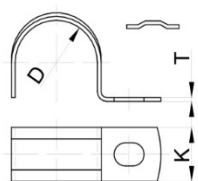

Kód Art. No.	D mm	K mm	T mm	kg/100ks kg/100pcs	balení/ks bag/pcs	karton/ks carton/pcs
5113.10	10	14	1	0,30	100	200
5113.12	13	14	1	0,35	100	200
5113.16	16	14	1	0,62	100	200
5113.19	19	14	1	0,80	50	100
5113.22	22	14	1	0,95	50	100
5113.26	26	14	1	1,05	50	100
5113.28	28	14	1	1,15	50	100
5113.32	32	14	1	1,35	50	100
5113.38	38	14	1	1,55	50	100
5113.50	50	14	1	1,90	25	50

## Objímka dvoubodová "C"

**povrch:** galvanický zinkochromát

**materiál:** ocel dle EN DD11; pevn.tř. 5.6; Rm 320MPa

**Pipeline clip double**

**finish:** galvanized > 10µm

**material:** carbon steel

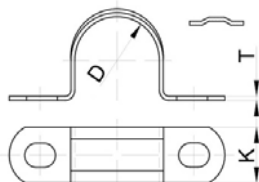

Kód Art. No.	D mm	K mm	T mm	kg/100ks kg/100pcs	balení/ks bag/pcs	karton/ks carton/pcs
5114.10	10	14	1	0,38	100	200
5114.12	13	14	1	0,47	100	200
5114.16	16	14	1	0,82	100	200
5114.19	19	14	1	0,89	50	100
5114.22	22	14	1	0,97	50	100
5114.26	26	14	1	1,15	50	100
5114.28	28	14	1	1,30	50	100
5114.32	32	14	1	1,45	50	100
5114.38	38	14	1	2,30	50	100
5114.50	50	14	1	2,70	25	50

## Spona hadicová W1

**povrch:** galvanický zinkochromát

**materiál:** ocel dle EN DD11; pevn.tř. 5.6; Rm 320MPa

**Hose clamp W1**

**finish:** galvanized > 10µm

**material:** carbon steel

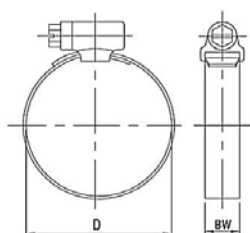

Kód Art. No.	rozsah potrubí mm	D mm	BW mm	kg/100ks kg/100pcs	balení/ks bag/pcs	karton/ks carton/pcs
5150.008	8 - 12	10	9	1,25	100	1 500
5150.012	12 - 20	16	9	1,40	100	1 000
5150.016	16 - 25	20	9	1,75	100	1 000
5150.025	25 - 40	32	9	1,90	50	1 000
5150.032	32 - 50	41	9	2,10	50	800
5150.040	40 - 60	50	9	2,30	50	800
5150.060	60 - 80	70	9	2,60	50	700
5150.070	70 - 90	80	9	2,80	50	700
5150.080	80 - 100	90	9	2,95	50	600
5150.090	90 - 110	100	9	3,15	50	500
5150.120	120 - 140	130	9	3,60	50	400
5150.140	140 - 160	150	9	4,00	25	300

## Úchyt patní s maticí

**povrch:** galvanický zinkochromát

**materiál:** ocel dle EN DD11; pevn.tř. 5.6; Rm 320MPa



**Bracket base with nut**

**finish:** galvanized > 10µm

**material:** carbon steel

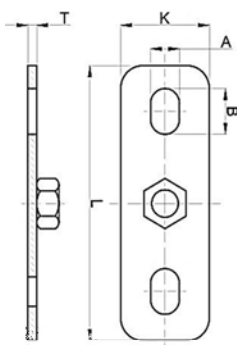

Kód Art. No.	L mm	K mm	T mm	A mm	B mm	matice nut	kg/100ks kg/100pcs	balení/ks bag/pcs	karton/ks carton/pcs
5122.08	80	30	2	9	18	M8	2,80	20	600
5122.10	80	30	2	9	18	M10	3,20	20	500
5122.09	120	40	4	13	20	M8	6,20	20	300
5122.11	120	40	4	13	20	M10	7,50	20	250
5122.12	120	40	4	13	20	M12	8,30	10	200
5122.16	120	40	4	13	20	M16	9,40	10	200

## Závěs trapzový s maticí

**povrch:** galvanický zinkochromát

**materiál:** ocel dle EN DD11; pevn.tř. 5.6; Rm 320MPa



**Beam support with nut**

**finish:** galvanized > 10µm

**material:** carbon steel

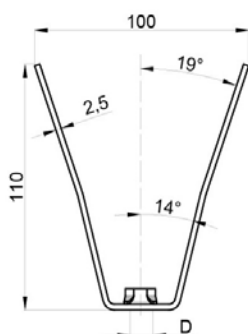

Kód Art. No.	L mm	plech mm	D mm	L1 mm	přípustné zatížení WLL (N)	kg/100ks kg/100pcs	balení/ks bag/pcs	karton/ks carton/pcs
5123.08	110	2,5	M8	100	1300	8,70	25	600
5123.10	110	2,5	M10	100	1300	8,80	25	200

## Závěs na nosník

**povrch:** galvanický zinkochromát > 10µm

**materiál:** temperovaná litina dle DIN EN 1562



**Beam support**

**finish:** galvanized > 10µm

**material:** malleable iron

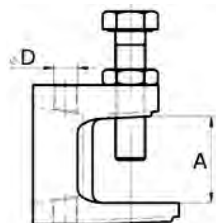

Kód Art. No.	šroub bolt	D mm	A mm	A mm	max. odolnost max. resistance	kg/100ks kg/100pcs	balení/ks bag/pcs	karton/ks carton/pcs
5124.08	M8	M8	18	18	800kg	9,20	50	250
5124.10	M10	M10	20	20	1000kg	14,10	25	200
5124.12	M12	M12	26	26	1000kg	16,30	10	150

## Kotva plášťová - hák

**povrch:** galvanický zinkochromát > 8µm

**materiál:** ocel pevn.tř.6.8

**Anchor with hook**

**finish:** galvanized > 8µm

**material:** hexagon screw quality 6.8

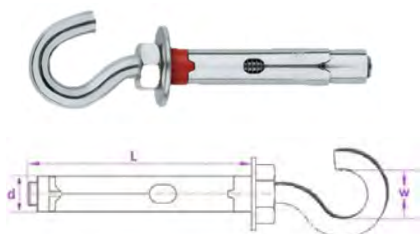

Kód Art. No.	závit thread	d mm	L mm	w mm	kN kN	kg/100ks kg/100pcs	balení/ks bag/pcs	karton/ks carton/pcs
5051.064	M6	8	45	10	1,5		50	600
5051.086	M8	10	60	13	3,0		50	400
5051.107	M10	12	70	14	5,0		25	200
5051.128	M12	16	80	22	6,5		10	100

1kN = 100Kg - povolené zatížení v tahu

1kN = 100Kg - tension

## Kotva plášťová - oko

**povrch:** galvanický zinkochromát > 8µm

**materiál:** ocel pevn.tř.6.8

**Anchor with eye**

**finish:** galvanized > 8µm

**material:** hexagon screw quality 6.8

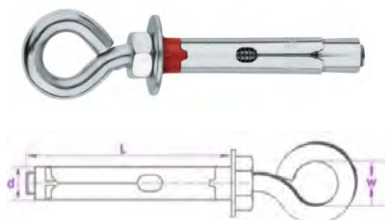

Kód Art. No.	závit thread	d mm	L mm	w mm	kN kN	kg/100ks kg/100pcs	balení/ks bag/pcs	karton/ks carton/pcs
5052.064	M6	8	45	10	1,5		50	600
5052.086	M8	10	60	13	3,0		50	400
5052.107	M10	12	70	14	5,0		25	200
5052.128	M12	16	80	22	6,5		10	100

1kN = 100Kg - povolené zatížení v tahu

1kN = 100Kg - tension

## Kotva plášťová - matice

**povrch:** galvanický zinkochromát > 8µm

**materiál:** ocel pevn.tř.6.8

**Anchor nut**

**finish:** galvanized > 8µm

**material:** hexagon screw quality 6.8

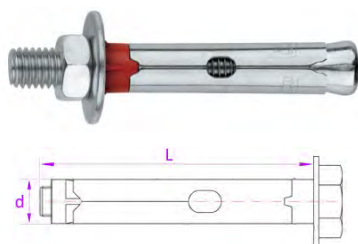

Kód Art. No.	závit thread	d mm	L mm			kg/100ks kg/100pcs	balení/ks bag/pcs	karton/ks carton/pcs
5053.064	M6	8	45				50	1 200
5053.086	M8	10	60				50	600
5053.088	M8	10	80				50	400
5053.107	M10	12	70				25	200
5053.110	M10	12	100				25	200

## Kotva plášťová - šroub

**povrch:** galvanický zinkochromát > 8µm

**materiál:** ocel pevn.tř.6.8

**Anchor bolt**

**finish:** galvanized > 8µm

**material:** hexagon screw quality 6.8

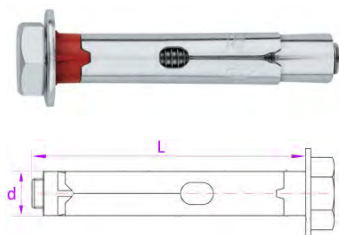

Kód Art. No.	závit thread	d mm	L mm			kg/100ks kg/100pcs	balení/ks bag/pcs	karton/ks carton/pcs
5054.064	M6	8	45				50	1 200
5054.086	M8	10	60				50	600
5054.088	M8	10	80				50	400
5054.107	M10	12	70				25	200
5054.110	M10	12	100				25	200



## Kotva průvleková

**povrch:** galvanický zinkochromát > 8µm

**materiál:** ocel pevn.tř.8

**Through bolt anchor**

**finish:** galvanized > 8µm

**material:** hexagon screw quality 8



Kód Art. No.	závit thread <sup>d</sup>	d mm	L mm	kg/100ks kg/100pcs	balení/ks bag/pcs	karton/ks carton/pcs
5055.064	M6	6	45		100	1 200
5055.066	M6	6	60		100	1 200
5055.086	M8	8	60		100	800
5055.089	M8	8	90		50	600
5055.107	M10	10	70		50	400
5055.109	M10	10	90		25	400
5055.112	M10	10	120		25	300
5055.127	M12	12	75		25	300
5055.129	M12	12	90		25	200
5055.131	M12	12	110		25	200
5055.172	M16	16	125		10	100
5055.174	M16	16	145		10	100
5055.177	M16	16	170		10	75

- možnost i jiných rozměrů na objednávku

*possibility other sizes for order only*

## Kotva průvleková - ETA Option7

**povrch:** galvanický zinkochromát > 8µm

**materiál:** ocel pevn.tř.8

**Through bolt anchor - ETA Option7**

**finish:** galvanized > 8µm

**material:** hexagon screw quality 8



Kód Art. No.	závit thread	d mm	L mm	kg/100ks kg/100pcs	balení/ks bag/pcs	karton/ks carton/pcs
5057.064	M6	6	45		100	1 200
5057.066	M6	6	60		100	1 200
5057.086	M8	8	60		100	800
5057.089	M8	8	90		50	600
5057.107	M10	10	70		50	400
5057.109	M10	10	90		25	400
5057.112	M10	10	120		20	300
5057.127	M12	12	75		10	300
5057.129	M12	12	90		10	200
5057.131	M12	12	110		10	200
5057.172	M16	16	125		5	100
5057.174	M16	16	145		5	100
5057.177	M16	16	170		5	75

- možnost i jiných rozměrů na objednávku

*possibility other sizes for order only*





Nábytkové příslušenství  
*Furniture accessories*

## Zástrč Z1

**povrch:** galvanický zinkochromát  
**materiál:** ocel



### Latch Z1

**finish:** galvanized  
**material:** steel

Kód Art. No.	A mm	B mm	C mm	kg/100ks kg/100pcs	balení/ks bag/pcs	karton/ks carton/pcs
6301.50Z	50	40	13	3,7	24	240
6301.70Z	70	50	15	6,1	24	240

**povrch:** pomosazený

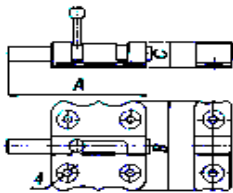

**finish:** brass plated

Kód Art. No.	A mm	B mm	C mm	kg/100ks kg/100pcs	balení/ks bag/pcs	karton/ks carton/pcs
6301.50M	50	40	13	3,7	24	240
6301.70M	70	50	15	6,1	24	240

## Zástrč Z2

**povrch:** galvanický zinkochromát  
**materiál:** ocel



### Latch Z2

**finish:** galvanized  
**material:** steel

Kód Art. No.	A mm	B mm	C mm	kg/100ks kg/100pcs	balení/ks bag/pcs	karton/ks carton/pcs
6302.Z06	60	32	15	4,3	24	480
6302.Z08	80	32	15	4,9	24	360
6302.Z10	100	32	15	6,4	24	240
6302.Z12	120	32	15	7,7	24	120
6302.Z14	140	32	15	8,8	24	120

**povrch:** černý zinkochromát

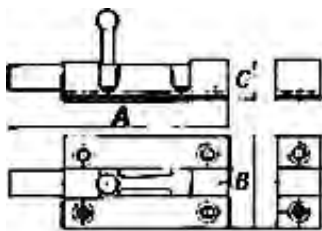

**finish:** black galvanized

Kód Art. No.	A mm	B mm	C mm	kg/100ks kg/100pcs	balení/ks bag/pcs	karton/ks carton/pcs
6302.C06	60	32	15	4,3	24	480
6302.C08	80	32	15	4,9	24	360
6302.C10	100	32	15	6,4	24	240
6302.C12	120	32	15	7,7	24	120
6302.C14	140	32	15	8,8	24	120

## Zástrč Z3

**materiál:** masivní mosaz

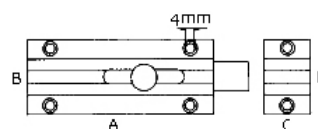

### Latch Z3

**material:** solid brass

Kód Art. No.	A mm	B mm	C mm	kg/100ks kg/100pcs	balení/ks bag/pcs	karton/ks carton/pcs
6303.060M	60	30	20	5,7	5	100
6303.080M	80	30	20	7,4	5	100
6303.100M	100	30	20	8,8	5	100

## Zástrč nábytková ZN1

**povrch:** galvanický zinkochromát Z - bílý, M - žlutý  
**materiál:** ocel

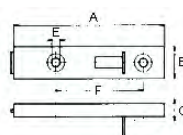

### Furniture latch ZN1

**finish:** Z - galvanized, M - tropicalized  
**material:** steel

Kód Art. No.	A mm	B mm	C mm	F mm	kg/100ks kg/100pcs	balení/ks bag/pcs	karton/ks carton/pcs
6321.70M	70	15	6,5	42	1,3	50	1 000
6321.70Z	70	15	6,5	42	1,3	50	1 000

## Zástrč vratová pevnostní

**povrch:** leštěný  
**materiál:** ocel, mosaz

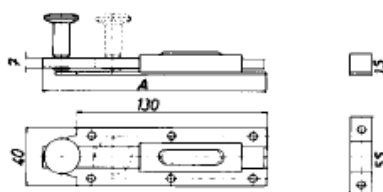

### Heavy door latch

**finish:** polished steel  
**material:** steel, brass

Kód Art. No.	A mm	B mm	C mm	D mm	kg/100ks kg/100pcs	balení/ks bag/pcs	karton/ks carton/pcs
6326.150	150	40	15	55	28,9	4	12
6326.200	200	40	15	55	32,8	4	12
6326.250	250	40	15	55	36,8	4	12
6326.300	300	40	15	55	41,0	4	12

## Zástrč zamykací M3

**povrch:** žlutý zinkochromát  
**materiál:** ocel, mosaz

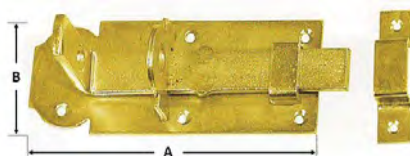

### Latch to be locked M3

**finish:** tropicalized  
**material:** steel

Kód Art. No.	A mm	B mm	C mm	kg/100ks kg/100pcs	balení/ks bag/pcs	karton/ks carton/pcs
6333.080	80	30	3	5,0	10	200
6333.100	100	45	5	19,0	10	100
6333.120	120	45	5	23,0	10	100

## Závěs na kazety

povrch: pomosazený  
materiál: ocel

**Casket hinge**

finish: brass plated  
material: steel

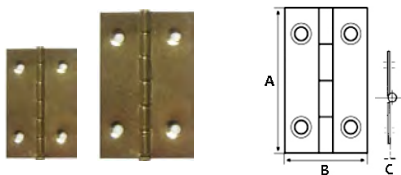

Kód Art. No.	A mm	B mm	C mm	Ø díry hole dia.	kg/100ks kg/100pcs	balení/ks bag/pcs	karton/ks carton/pcs
6400.1315	15	13	0,5	1,5	0,10	250	2 000
6400.1520	20	15	0,5	1,5	0,15	200	2 000
6400.2030	30	20	0,5	2,2	0,29	100	1 000

## Uzávěr na kazety

povrch: pomosazený  
materiál: ocel

**Casket closure**

finish: brass plated  
material: steel



Kód Art. No.	A mm	B mm	kg/100ks kg/100pcs	balení/ks bag/pcs	karton/ks carton/pcs
6400.U25	25	25	0,15	50	500

## Háček na kazety

povrch: pomosazený  
materiál: ocel

**Casket hook**

finish: brass plated  
material: steel

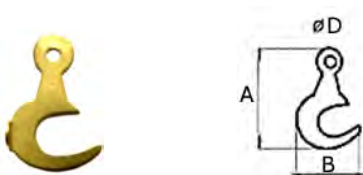

Kód Art. No.	A mm	B mm	D mm	kg/100ks kg/100pcs	balení/ks bag/pcs	karton/ks carton/pcs
6400.HL	20	14	1,8	0,05	100	1 000
6400.HP	20	14	1,8	0,05	100	1 000

## Držák šatní tyče D1

povrch: pochromovaný  
materiál: ocel

**Tube support D1**

finish: chrome plated  
material: steel



Kód Art. No.	rozměry viz. náčrtes v mm dimensions acc. Figure mm	kg/100ks kg/100pcs	balení/ks bag/pcs	karton/ks carton/pcs
6451.25		2,70	20	600

## Držák šatní tyče D2

povrch: pomosazený  
materiál: zinková slitina

**Tube support D2**

finish: brass plated  
material: zamak

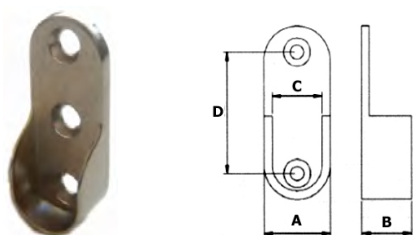

Kód Art. No.	A mm	B mm	C mm	D mm	kg/100ks kg/100pcs	balení/ks bag/pcs	karton/ks carton/pcs
6452.30M	20	15	15	32	1,10	50	1 000

povrch: poniklovaný

finish: nickel plated

6452.30N	20	15	15	32	1,10	50	1 000
----------	----	----	----	----	------	----	-------

## Závěs kloubový Z1

povrch: galvanický zinkochromát  
materiál: ocel

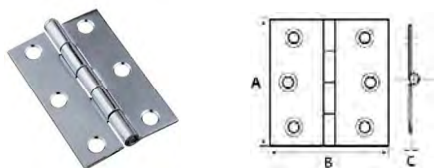

## Hinge Z1

finish: galvanized  
material: steel

Kód Art. No.	A mm	B mm	C mm	Ø díry hole dia.	kg/100ks kg/100pcs	balení/ks bag/pcs	karton/ks carton/pcs
6401.040	40	25	1,0	3,5	1,2	50	1 500
6401.050	50	35	1,0	3,5	1,9	50	1 000
6401.060	60	40	1,0	3,5	2,8	50	800

## Závěs kloubový Z2

povrch: galvanický zinkochromát  
materiál: ocel

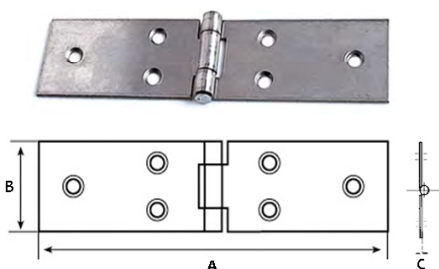

## Hinge Z2

finish: galvanized  
material: steel

Kód Art. No.	A mm	B mm	C mm	Ø díry hole dia.	kg/100ks kg/100pcs	balení/ks bag/pcs	karton/ks carton/pcs
6402.050	50	20	1,0	3,2	1,0	50	2 000
6402.060	60	22	1,0	3,2	1,4	50	1 500
6402.080	80	25	1,3	3,2	2,4	50	1 000
6402.100	100	25	1,3	3,2	2,8	25	800
6402.120	120	25	1,3	3,2	3,1	25	500
6402.160	160	29	1,5	4,5	6,3	24	240

## Závěs kloubový s volným čepem

povrch: poniklovaný  
materiál: ocel

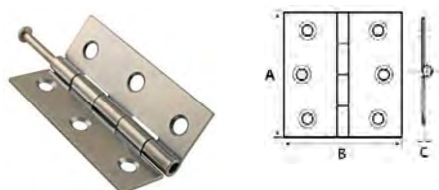

## Hinge with loose pin

finish: nickel plated  
material: steel

Kód Art. No.	A mm	B mm	C mm	Ø díry hole dia.	kg/100ks kg/100pcs	balení/ks bag/pcs	karton/ks carton/pcs
6403.040	40	35	1,0	3,5	1,4	24	2 000
6403.050	50	40	1,0	3,5	2,0	24	1 500
6403.060	60	50	1,0	3,8	2,8	24	1 000
6403.070	70	55	1,0	4,3	4,4	24	800

## Závěs kloubový Z4

povrch: galvanický zinkochromát  
materiál: ocel

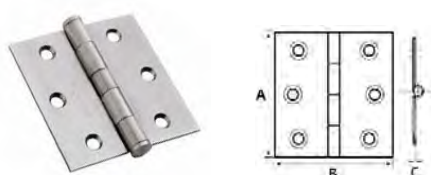

## Hinge Z4

finish: galvanized  
material: steel

Kód Art. No.	A mm	B mm	C mm	Ø díry hole dia.	kg/100ks kg/100pcs	balení/ks bag/pcs	karton/ks carton/pcs
6404.30Z	30	30	1,0	3,2	0,90	50	2 000
6404.40Z	40	40	1,0	3,2	1,55	50	800
6404.50Z	50	45	1,0	3,5	2,30	50	800
6404.60Z	60	50	1,0	3,8	2,75	25	400
6404.70Z	70	60	1,0	4,3	4,40	25	400
6404.80Z	80	70	1,2	4,6	6,00	25	300

materiál: nerezavějící ocel A4



material: stainless steel AISI 316

Kód Art. No.	A mm	B mm	C mm	Ø díry hole dia.	kg/100ks kg/100pcs	balení/ks bag/pcs	karton/ks carton/pcs
9404.3030	30	30	1,0	3,2	0,90	12	2 000
9404.4040	40	40	1,0	3,2	1,55	12	800
9404.5050	50	50	1,0	3,5	2,30	12	800
9404.6050	60	50	1,0	3,8	2,75	12	400

## Závěs kloubový Z5

povrch: galvanický zinkochromát  
materiál: ocel

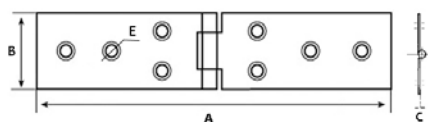

### Hinge Z5

finish: galvanized  
material: steel

Kód Art. No.	A mm	B mm	C mm	E mm	kg/100ks kg/100pcs	balení/ks bag/pcs	karton/ks carton/pcs
6405.150	150	44	2,0	5,5	11,7	25	120
6405.200	200	44	2,0	5,5	15,1	25	120

## Závěs kloubový Z7

povrch: galvanický zinkochromát  
materiál: ocel

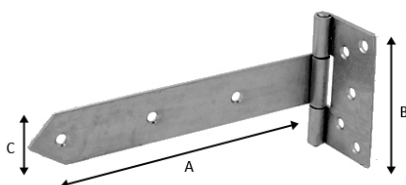

### Hinge Z7

finish: galvanized  
material: steel

Kód Art. No.	A mm	B mm	C mm	plech plate	kg/100ks kg/100pcs	balení/ks bag/pcs	karton/ks carton/pcs
6407.150	150	86	34	2,5	21,5	10	100
6407.200	200	86	34	2,5	23,9	10	100
6407.250	250	86	34	2,5	26,7	10	80
6407.300	300	86	34	2,5	29,4	10	60

## Závěs kloubový OZ4

povrch: brunýrovaný  
materiál: ocel

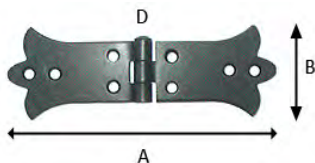

### Hinge OZ4

finish: burnished  
material: steel

Kód Art. No.	A mm	B mm	D mm	E mm	kg/100ks kg/100pcs	balení/ks bag/pcs	karton/ks carton/pcs
6414.087	87	50	7,6	4,5	4,2	24	240
6414.135	135	45	9,4	4,5	7,4	24	240

## Závěs kloubový OZ5

povrch: brunýrovaný  
materiál: ocel

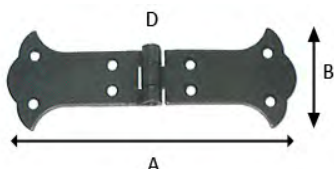

### Hinge OZ5

finish: burnished  
material: steel

Kód Art. No.	A mm	B mm	D mm	E mm	kg/100ks kg/100pcs	balení/ks bag/pcs	karton/ks carton/pcs
6415.085	85	50	7,6	4,5	4,7	24	240
6415.135	135	47	9,4	4,5	6,8	24	240

## Závěs kloubový OZ6

povrch: brunýrovaný  
materiál: ocel

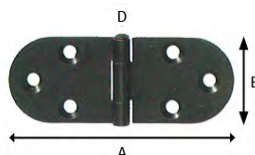

### Hinge OZ6

finish: burnished  
material: steel

Kód Art. No.	A mm	B mm	D mm	E mm	kg/100ks kg/100pcs	balení/ks bag/pcs	karton/ks carton/pcs
6416.045	45	30	6,0	4,5	1,8	24	240
6416.080	80	30	7,6	4,5	4,0	24	240

## Závěs kloubový OZ8

povrch: brunýrovaný  
materiál: ocel

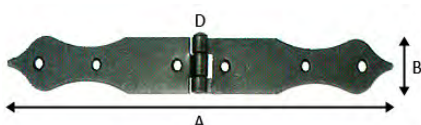

### Hinge OZ8

finish: burnished  
material: steel

Kód Art. No.	A mm	B mm	D mm	E mm	kg/100ks kg/100pcs	balení/ks bag/pcs	karton/ks carton/pcs
6418.148	148	28	9,4	4,5	5,9	24	240
6418.224	224	25	9,4	4,5	8,2	24	240



## Závěs bajonetový ZB1

povrch: galvanický zinkochromát  
materiál: ocel



### Cabinet hook ZB1

finish: galvanized  
material: steel

Kód Art. No.	A mm	B mm	plech plate	díry Ø holes Ø	kg/100ks kg/100pcs	balení/ks bag/pcs	karton/ks carton/pcs
6431.060	60	20	1,5	4,5	0,8	100	2 000
6431.080	80	20	1,5	4,5	1,6	100	1 500
6431.100	100	20	1,5	4,5	2,1	50	1 000

## Závěs bajonetový ZB2

povrch: galvanický zinkochromát  
materiál: ocel

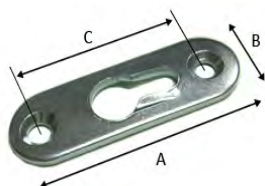

### Cabinet hook ZB2

finish: galvanized  
material: steel

Kód Art. No.	A mm	B mm	C mm	plech plate	kg/100ks kg/100pcs	balení/ks bag/pcs	karton/ks carton/pcs
6432.050	50	15	34	2,0	0,8	100	2 000

## Závěs skříňový ZS1

povrch: galvanický zinkochromát  
materiál: ocel

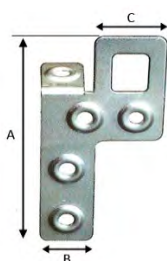

### Cabinet hook ZS1

finish: galvanized  
material: steel

Kód Art. No.	A mm	B mm	C mm	plech mm	kg/100ks kg/100pcs	balení/ks bag/pcs	karton/ks carton/pcs
6434.L85	85	18	28	1,2	3,2	50	600
6434.P85	85	18	28	1,2	3,2	50	600

## Závěs skříňový ZS2

povrch: galvanický zinkochromát  
materiál: ocel

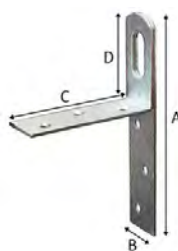

### Cabinet hook ZS2

finish: galvanized  
material: steel

Kód Art. No.	A mm	B mm	C mm	D mm	kg/100ks kg/100pcs	balení/ks bag/pcs	karton/ks carton/pcs
6435.100	100	20	62	40	2,9	50	800

## Postelové kování

povrch: galvanický zinkochromát - žlutý  
materiál: ocel

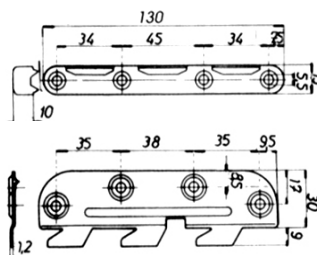

### Bed hinge

material: steel  
finish: tropicalized

Kód Art. No.	rozměry viz. náčres v mm dimensions acc. Figure mm	kg/100ks kg/100pcs	balení/ks bag/pcs	karton/ks carton/pcs
6441.130	1 kus = sada 8 dílů	28,4	10	100

## Kolík policový K1

**povrch:** M - pomosazený, N - poniklovaný  
**materiál:** ocel

### Shelf support K1

**finish:** M - brass plated, N - nickel plated  
**material:** steel



Kód Art. No.	A mm	B mm	C mm	kg/100ks kg/100pcs	balení/ks bag/pcs	karton/ks carton/pcs
6500.5M	5	16	8	0,25	500	10 000
6500.7M	7	27	8	0,56	500	5 000
6500.5N	5	16	8	0,25	500	10 000
6500.7N	7	27	8	0,56	500	5 000

## Protikus pro K1 (7mm)

**povrch:** M - pomosazený, N - poniklovaný  
**materiál:** ocel

### Sleeve for art. K1 (7mm)

**finish:** M - brass plated, N - nickel plated  
**material:** steel

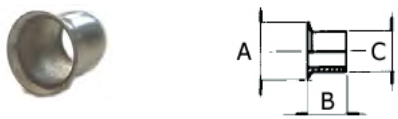

Kód Art. No.	A mm	B mm	C mm	kg/100ks kg/100pcs	balení/ks bag/pcs	karton/ks carton/pcs
6501.8M	10	9	8	0,07	500	5 000
6501.8N	10	9	8	0,07	500	5 000

## Kolík policový K2

**povrch:** pomosazený  
**materiál:** ocel

### Shelf support K2

**finish:** brass plated  
**material:** steel



Kód Art. No.	A mm	B mm	povrch finish	kg/100ks kg/100pcs	balení/ks bag/pcs	karton/ks carton/pcs
6502.5M	5	16	mosaz / brass	0,24	500	10 000
6502.5N	5	16	nikl / nickel	0,24	500	10 000
6502.5Z	5	16	zinek/galvanized	0,24	500	10 000

## Kolík policový K3

**povrch:** M - žlutý zinek, Z - bílý zinek  
**materiál:** ocel

### Shelf support K3

**finish:** M - tropicalized, Z - galvanized  
**material:** steel



Kód Art. No.	A mm	B mm	C mm	kg/100ks kg/100pcs	balení/ks bag/pcs	karton/ks carton/pcs
6503.5M	3	16	5	0,21	500	10 000
6503.5Z	3	16	5	0,21	500	10 000
6503.7M	5	16	7	0,35	500	10 000
6503.7Z	5	16	7	0,35	500	10 000

## Kolík policový na sklo

**povrch:** poniklovaný  
**materiál:** ocel

### Shelf support for glass

**finish:** nickel plated  
**material:** steel

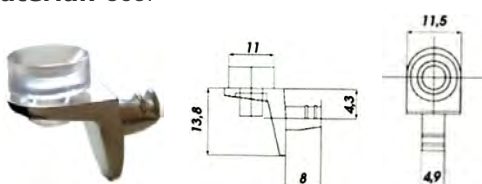

Kód Art. No.	rozměry viz. nákres v mm dimensions acc. Figure mm	kg/100ks kg/100pcs	balení/ks bag/pcs	karton/ks carton/pcs
6506.8N	11,5 4,9 13,8 8,0 4,3	0,50	100	2 000

## Podpěra zápustná PZ1

**povrch:** galvanický zinkochromát  
**materiál:** ocel

## Shelf support PZ1

**finish:** galvanized  
**material:** steel

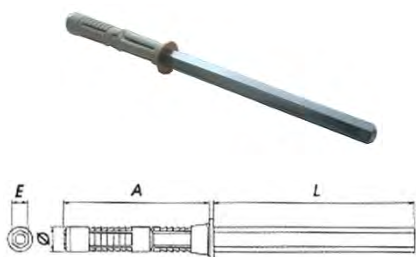

Kód Art. No.	L mm	E mm	A mm	Ø mm	kg/100ks kg/100pcs	balení/ks bag/pcs	karton/ks carton/pcs
6511.0812	120	8	70	12	7,9	10	50
6511.0814	145	8	70	12	8,8	10	50
6511.1014	145	10	75	12	13,5	5	20
6511.1017	170	10	75	12	15,9	5	20
6511.1217	170	12	80	14	21,7	5	20
6511.1220	200	12	80	14	24,9	5	20

## Konzole policová s prolisem

**povrch:** stříbrný lak  
**materiál:** ocel

## Pressed shelf bracket

**finish:** silver painted  
**material:** steel



Kód Art. No.	A mm	B mm	C mm	kg/100ks kg/100pcs	balení/ks bag/pcs	karton/ks carton/pcs
6549.S15	110	150	38	7,0	10	200
6549.S20	140	200	38	13,0	10	150
6549.S24	147	240	38	16,5	10	100

**povrch:** bílý lak

**finish:** white painted

6549.B15	110	150	38	7,0	10	200
6549.B20	140	200	38	13,0	10	150
6549.B24	147	240	38	16,5	10	100

**povrch:** černý lak

**finish:** black painted

6549.C15	110	150	38	7,0	10	200
6549.C20	140	200	38	13,0	10	150
6549.C24	147	240	38	16,5	10	100

## Konzola dekorativní kovaná - KD1

**povrch:** černý lak  
**materiál:** ocel

## Decorative shelf bracket - KD1

**finish:** black painted  
**material:** steel

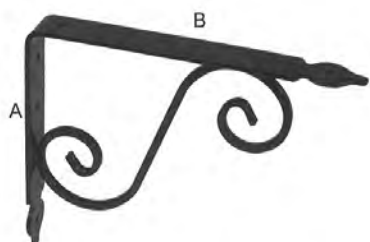

Kód Art. No.	A mm	B mm	C mm	kg/100ks kg/100pcs	balení/ks bag/pcs	karton/ks carton/pcs
6550.C140	110	140	25	18,0	2	120
6550.C190	140	190	25	24,0	2	96
6550.C240	190	240	25	50,0	2	48

**povrch:** stříbrný lak

**finish:** silver painted

6550.S140	110	140	25	18,0	2	120
6550.S190	140	190	25	24,0	2	96
6550.S240	190	240	25	50,0	2	48

## Konzola bez podpěry

**povrch:** galvanický zinkochromát  
**materiál:** ocel

**Bracket**

**finish:** galvanized  
**material:** steel

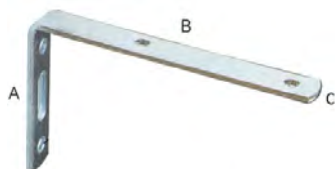

Kód Art. No.	B mm	A mm	C mm	plech plate	kg/100ks kg/100pcs	balení/ks bag/pcs	karton/ks carton/pcs
6573.06Z	60	70	15	3,0	3,5	50	500
6573.10Z	100	70	15	3,0	5,2	50	500
6573.15Z	150	70	15	3,0	8,5	50	500
6573.17Z	150	70	20	3,5	10,6	40	400
6573.20Z	200	70	15	3,0	11,8	50	500
6573.22Z	200	70	20	3,5	13,9	40	400

## Konzola s podpěrou KP1

**povrch:** galvanický zinkochromát  
**materiál:** ocel

**Bracket with support KP1**

**finish:** galvanized  
**material:** steel

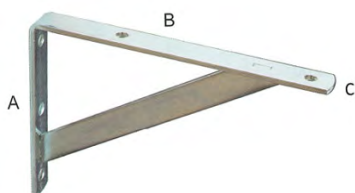

Kód Art. No.	A mm	B mm	C mm	plech plate	kg/100ks kg/100pcs	balení/ks bag/pcs	karton/ks carton/pcs
6574.15Z	150	100	15	3,0	12,7	20	200
6574.20Z	200	100	15	3,0	14,5	20	160
6574.25Z	250	100	15	3,0	16,2	20	120
6574.30Z	300	100	20	4,0	23,2	10	100
6574.35Z	350	100	20	4,0	30,3	10	80
6574.40Z	400	100	20	4,0	38,5	10	60

## Konzola s podpěrou KP2

**povrch:** galvanický zinkochromát  
**materiál:** ocel

**Bracket with support KP2**

**finish:** galvanized  
**material:** steel

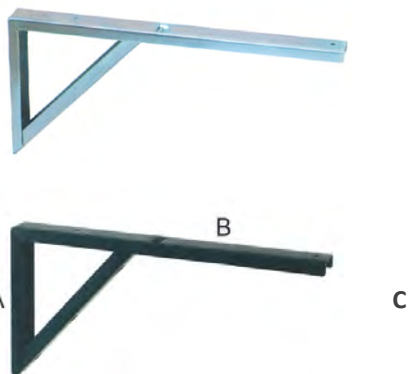

Kód Art. No.	A mm	B mm	C mm	kg/100ks kg/100pcs	balení/ks bag/pcs	karton/ks carton/pcs
6576.Z30	180	300	26	44,2	10	100
6576.Z40	180	400	26	48,8	5	50

**povrch:** bílý lak

**finish:** white painted

6576.B30	180	300	26	44,2	10	100
6576.B40	180	400	26	48,8	5	50

**povrch:** černý lak

**finish:** black painted

6576.C30	180	300	26	44,2	10	100
6576.C40	180	400	26	48,8	5	50

## Krytka na zrcadlový vrut

**povrch:** pomosazený

**materiál:** ocel

**Screw cap for mirror**

**finish:** brass plated

**material:** steel

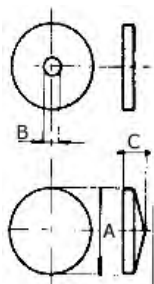

**povrch:** poniklovaný

Kód Art. No.	A mm	B mm	C mm	kg/100ks kg/100pcs	balení/ks bag/pcs	karton/ks carton/pcs
6600.16M	16	5	6	0,19	500	5 000
6600.20M	20	5	7	0,27	500	5 000
6600.24M	24	5	8	0,35	250	5 000

**finish:** nickel plated

6600.16N	16	5	6	0,19	250	5 000
6600.20N	20	5	7	0,27	200	4 000
6600.24N	24	5	8	0,35	100	3 000

## Sklapka magnetická

**barva:** B - bílá, H - hnědá

**Magnetic catch**

**colour:** B - white, H - Brown

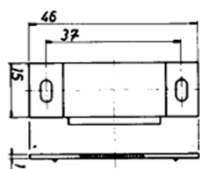

Kód Art. No.	rozměry viz. náčrtes dimensions acc. Figure	tah kg force	kg/100ks kg/100pcs	balení/ks bag/pcs	karton/ks carton/pcs
6610.06B	46 15 37	6	2,16	50	1 000
6610.06H	46 15 37	6	2,16	50	1 000

## IXA háček

**povrch:** pomosazený

**materiál:** ocel

**X type hook**

**finish:** brass plated

**material:** steel



Kód Art. No.	vel. size	h mm	hřebík nail mm	kg/100ks kg/100pcs	balení/ks bag/pcs	karton/ks carton/pcs
6700.00	0	16	1,0 x 25	0,13	500	5 000
6700.01	1	23	1,0 x 25	0,16	250	5 000
6700.02	2	28	1,0 x 25	0,18	250	5 000
6700.03	3	32	1,0 x 25	0,50	100	2 500

## Hřebík kalený s mosaznou hlavou

**povrch:** bez dalších úprav

**materiál:** kalená ocel + mosaz

**Tempered nail with brass head**

**finish:** blunk

**material:** tempered steel + brass



Kód Art. No.	L mm	d mm	kg/100ks kg/100pcs	balení/ks bag/pcs	karton/ks carton/pcs
6701.20	20	2,0	0,08	100	1 000
6701.25	25	2,0	0,10	100	1 000
6701.30	30	2,0	0,12	100	1 000

## Očko obrazové

povrch: pomosazený  
materiál: ocel

**Picture hook**

finish: brass plated  
material: steel

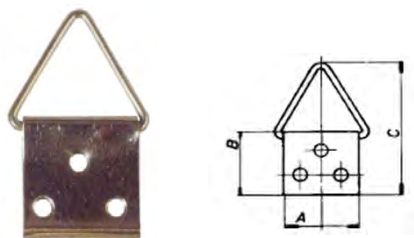

Kód Art. No.	vel. size	A mm	B mm	C mm	kg/100ks kg/100pcs	balení/ks bag/pcs	karton/ks carton/pcs
6702.00	0	8	7	16	0,05	500	5 000
6702.01	1	10	9	20	0,06	500	5 000
6702.02	2	12	11	23	0,08	250	5 000
6702.03	3	14	12	28	0,10	250	5 000
6702.04	4	16	15	31	0,16	200	4 000
6702.05	5	20	18	39	0,23	100	3 000

## Závěs obrazový

povrch: pomosazený  
materiál: ocel

**Picture hook**

finish: brass plated  
material: steel



Kód Art. No.	L mm	typ type	povrch finish	kg/100ks kg/100pcs	balení/ks bag/pcs	karton/ks carton/pcs
6705.23	23	1	pozink	0,12	100	5 000
6705.40	40	2	mosaz	0,18	100	5 000
6705.60	60	2	mosaz	0,28	100	5 000

## Háček do betonu - TWENTY

materiál: bílý polyamid

**Concrete hook**

material: white nylon



Kód Art. No.	vel. size	L mm	kg/100ks kg/100pcs	balení/ks bag/pcs	karton/ks carton/pcs
6703.01	1	10	0,04	200	3 000
6703.02	2	23	0,09	100	2 000
6703.03	3	30	0,17	100	1 000
6703.04	4	36	0,25	50	500

## Háček přísavný

povrch: pozinkovaný  
materiál: bezbarvý polyetylén + ocel

**Sticky hook**

finish: galvanized  
material: natural ethylene + steel

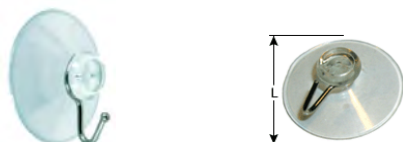

Kód Art. No.	L mm	kg/100ks kg/100pcs	balení/ks bag/pcs	karton/ks carton/pcs
6704.25	25	0,15	100	2 500
6704.30	30	0,25	50	2 000
6704.40	40	0,45	50	1 000

## Klip - Háček magnetický

povrch: poniklovaný  
materiál: ocel

**Magnetic hook - clip**

finish: nickel plated  
material: steel

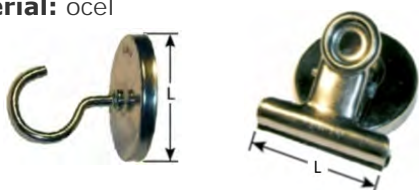

Kód Art. No.	L mm	provedení type	kg/100ks kg/100pcs	balení/ks bag/pcs	karton/ks carton/pcs
6706.30	40	háček	0,45	10	200
6707.30	40	klip	0,45	10	200



Tesařské a spojovací kování  
*Fitting and Ground screw*

## Úhelník UP1

**povrch:** galvanický zinkochromát (bílý) > 8µm  
**materiál:** ocel S235JR, pevn.tř.4.6, Re 235MPa



### Corner plate UP1

**finish:** galvanized > 8µm  
**material:** forged steel St37-2

E = Ø4,5mm

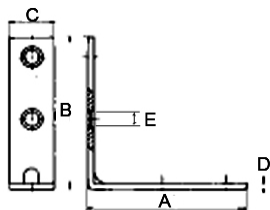

Kód Art. No.	A mm	B mm	C mm	D mm	děr holes	kg/100ks kg/100pcs	balení/ks bag/pcs	karton/ks carton/pcs
6101.020	20	20	15	2	2	0,80	100	3 000
6101.030	30	30	15	2	4	1,15	100	2 500
6101.040	40	40	15	2	4	1,50	100	1 500
6101.050	50	50	15	2	4	1,95	100	1 000
6101.060	60	60	15	2	4	2,35	100	800
6101.070	70	70	15	2	4	2,90	100	600
6101.080	80	80	15	2	4	3,45	100	600
6101.100	100	100	15	2	4	4,05	100	600

## Úhelník UP2

**povrch:** galvanický zinkochromát (bílý) > 8µm  
**materiál:** ocel S235JR, pevn.tř.4.6, Re 235MPa



### Corner plate UP2

**finish:** galvanized > 8µm  
**material:** forged steel St37-2

E = Ø4,5mm

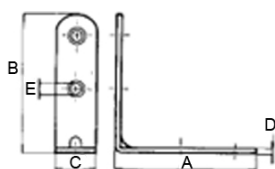

Kód Art. No.	A mm	B mm	C mm	D mm	děr holes	kg/100ks kg/100pcs	balení/ks bag/pcs	karton/ks carton/pcs
6102.020	20	20	15	2	2	0,75	100	3 000
6102.030	30	30	15	2	4	1,10	100	2 000
6102.040	40	40	15	2	4	1,45	100	1 500
6102.050	50	50	15	2	4	1,90	100	1 000
6102.060	60	60	15	2	4	2,30	100	800
6102.080	80	80	15	2	4	3,40	100	600

## Úhelník UP3

**povrch:** galvanický zinkochromát (bílý) > 8µm  
**materiál:** ocel S235JR, pevn.tř.4.6, Re 235MPa



### Corner plate UP3

**finish:** galvanized > 8µm  
**material:** forged steel St37-2

E = Ø4,5mm

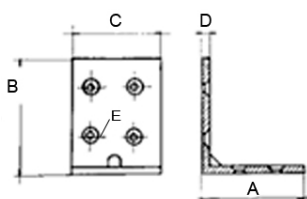

Kód Art. No.	A mm	B mm	C mm	D mm	děr holes	kg/100ks kg/100pcs	balení/ks bag/pcs	karton/ks carton/pcs
6103.020	20	20	30	2	2	0,80	100	3 000
6103.030	30	30	30	2	4	1,15	100	2 500
6103.040	40	40	30	2	4	1,50	100	1 500
6103.050	50	50	30	2	4	1,95	100	1 000
6103.060	60	60	30	2	4	2,35	100	800
6103.080	80	80	30	2	4	2,90	100	600
6103.100	100	100	30	2	4	3,45	100	600

## Úhelník UP4

**povrch:** galvanický zinkochromát (bílý) > 8µm  
**materiál:** ocel S235JR, pevn.tř.4.6, Re 235MPa



### Corner plate UP4

**finish:** galvanized > 8µm  
**material:** forged steel St37-2

E = Ø4,5mm

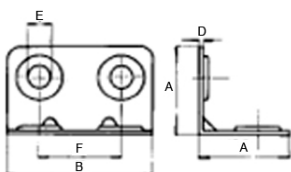

Kód Art. No.	A mm	B mm	D mm	F mm	děr holes	kg/100ks kg/100pcs	balení/ks bag/pcs	karton/ks carton/pcs
6104.40	20	40	1	23	4	1,00	100	2 000



## Úhelník UP4

**povrch:** galvanický zinkochromát (bílý) > 8µm  
**materiál:** ocel S235JR, pevn.tř.4.6, Re 235MPa



### Corner plate UP4

**finish:** galvanized > 8µm  
**material:** forged steel St37-2

**E = Ø4,5mm**

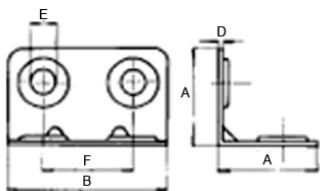

Kód Art. No.	A mm	B mm	D mm	F mm	děr holes	kg/100ks kg/100pcs	balení/ks bag/pcs	karton/ks carton/pcs
6104.50	21	21	1	32	4	1,50	100	1 500
6104.67	21	67	1	32	4	2,10	100	1 000
6104.86	21	86	1	32	6	2,60	50	800
6104.90	37	90	2	32	6	10,20	50	200

## Úhelník UP5

**povrch:** galvanický zinkochromát (bílý) > 8µm  
**materiál:** ocel S235JR, pevn.tř.4.6, Re 235MPa



### Corner plate UP5

**finish:** galvanized > 8µm  
**material:** forged steel St37-2

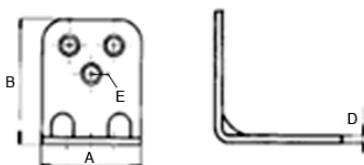

Kód Art. No.	A mm	B mm	D mm	E mm	děr holes	kg/100ks kg/100pcs	balení/ks bag/pcs	karton/ks carton/pcs
6105.30	30	30	1,8	4,5	8	2,40	100	1 200
6105.48	40	48	2,5	4,5	10	5,90	50	400

## Úhelník UP6

**povrch:** galvanický zinkochromát (bílý) > 8µm  
**materiál:** ocel S235JR, pevn.tř.4.6, Re 235MPa



### Corner plate UP6

**finish:** galvanized > 8µm  
**material:** forged steel St37-2

**E = Ø4,5mm**

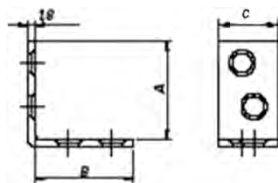

Kód Art. No.	A mm	B mm	C mm	plech mm	děr holes	kg/100ks kg/100pcs	balení/ks bag/pcs	karton/ks carton/pcs
6106.25	25	25	15	1,8	4	0,95	100	2 000
6106.40	40	40	15	1,8	4	1,55	100	1 500

## Úhelník UP7

**povrch:** galvanický zinkochromát (bílý) > 8µm  
**materiál:** ocel S235JR, pevn.tř.4.6, Re 235MPa



### Corner plate UP7

**finish:** galvanized > 8µm  
**material:** forged steel St37-2

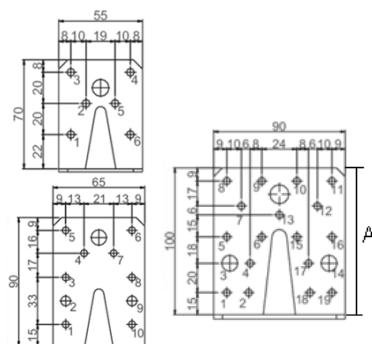

Kód Art. No.	A mm	B mm	plech mm	díry Ø5,7,11 holes Ø5,7,11mm	kg/100ks kg/100pcs	balení/ks bag/pcs	karton/ks carton/pcs
6107.060	60	40	2,0	12, 0, 2	8,0	50	300
6107.070	70	55	2,0	12, 0, 2	11,3	50	200
6107.090	85	65	2,5	16, 4, 2	20,8	25	100
6107.100	100	90	2,5	30, 4, 6	39,8	20	80

**materiál:** nerezavějící ocel A4

**material:** stainless steel AISI 316

9107.100	100	90	2,0	30, 4, 2	39,8	10	50
----------	-----	----	-----	----------	------	----	----

## Úhelník UP9

**povrch:** galvanický zinkochromát (bílý) > 10µm  
**materiál:** ocel S275JR, pevn. tř. 5.6, Re 275MPa

### Corner plate UP9

**finish:** galvanized > 10µm  
**material:** forged steel St 44-2

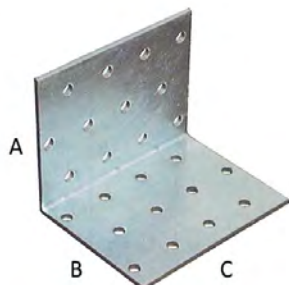

Kód Art. No.	A mm	B mm	C mm	plech mm	díry Ø mm	kg/100ks kg/100pcs	balení/ks bag/pcs	karton/ks carton/pcs
6109.0404	40	40	40	2,0	5	4,7	50	500
6109.0406	40	40	60	2,0	5	7,0	50	300
6109.0604	60	60	40	2,0	5	6,9	20	300
6109.0606	60	60	60	2,0	5	11,0	20	200
6109.0608	60	60	80	2,0	5	14,0	20	160
6109.0610	60	60	100	2,0	5	17,7	20	140
6109.0804	80	80	40	2,0	5	9,2	20	200
6109.0806	80	80	60	2,0	5	14,2	20	160
6109.0808	80	80	80	2,0	5	18,9	20	120
6109.0810	80	80	100	2,0	5	23,1	20	100
6109.1006	100	100	60	2,0	5	17,6	20	120
6109.1008	100	100	80	2,0	5	23,7	20	100
6109.1010	100	100	100	2,0	5	30,1	20	80

## Rohovník

**povrch:** galvanický zinkochromát (bílý) > 8µm  
**materiál:** ocel S235JR, pevn. tř. 4.6, Re 235MPa

### Corner

**finish:** galvanized > 8µm  
**material:** forged steel St37-2

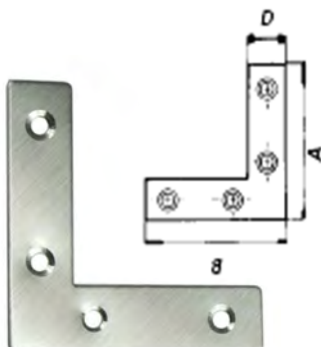

Kód Art. No.	A mm	B mm	D mm	Ø díry Ø hole	plech plate	kg/100ks kg/100pcs	balení/ks bag/pcs	karton/ks carton/pcs
6214.030	30	30	12	4,0	1,8	0,60	100	3 000
6214.040	40	40	12	4,0	1,8	0,85	100	2 000
6214.050	50	50	12	4,0	1,8	1,10	100	2 000
6214.060	60	60	12	4,0	1,8	1,45	100	1 500
6214.080	80	80	18	6,0	2,0	3,75	100	600
6214.100	100	100	18	6,0	2,0	4,85	50	500
6214.120	120	120	18	6,0	2,0	6,00	50	400
6214.140	140	140	18	6,0	2,0	7,20	50	300

## Plech spojovací PS1

**povrch:** galvanický zinkochromát (bílý) > 8µm  
**materiál:** ocel S235JR, pevn.tř.4.6, Re 235MPa



### Connecting plate PS1

**finish:** galvanized > 8µm  
**material:** forged steel St37-2

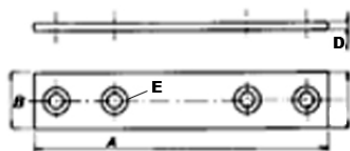

Kód Art. No.	A mm	B mm	D mm	E mm	děř holes	kg/100ks kg/100pcs	balení/ks bag/pcs	karton/ks carton/pcs
6201.040	40	15	2	4,0	2	0,80	100	2 500
6201.060	60	15	2	4,0	4	1,15	100	2 000
6201.080	80	15	2	4,0	4	1,50	100	1 500
6201.100	100	15	2	4,0	4	1,95	100	1 000
6201.120	120	15	2	4,0	4	2,35	100	800
6201.140	140	15	2	4,0	4	2,90	100	600
6201.160	160	15	2	4,0	4	3,45	100	600

## Plech spojovací PS2

**povrch:** galvanický zinkochromát (bílý) > 8µm  
**materiál:** ocel S235JR, pevn.tř.4.6, Re 235MPa



### Connecting plate PS2

**finish:** galvanized > 8µm  
**material:** forged steel St37-2

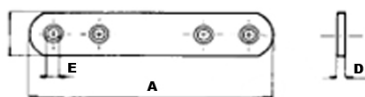

Kód Art. No.	A mm	B mm	C mm	E mm	děř holes	kg/100ks kg/100pcs	balení/ks bag/pcs	karton/ks carton/pcs
6202.040	40	15	2	4,0	2	0,75	100	2 500
6202.060	60	15	2	4,0	4	1,10	100	2 000
6202.080	80	15	2	4,0	4	1,45	100	1 500
6202.100	100	15	2	4,0	4	1,90	100	1 000
6202.120	120	15	2	4,0	4	2,30	100	800

## Plech spojovací PS3

**povrch:** galvanický zinkochromát (bílý) > 8µm  
**materiál:** ocel S235JR, pevn.tř.4.6, Re 235MPa



### Connecting plate PS3

**finish:** galvanized > 8µm  
**material:** forged steel St37-2

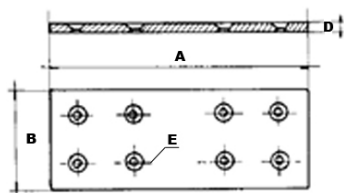

Kód Art. No.	A mm	B mm	D mm	E mm	děř holes	kg/100ks kg/100pcs	balení/ks bag/pcs	karton/ks carton/pcs
6203.040	40	30	2	4,5	4	1,50	50	1 500
6203.060	60	30	2	4,5	8	2,20	50	1 000
6203.080	80	30	2	4,5	8	3,05	50	800
6203.100	100	30	2	4,5	8	3,90	50	600
6203.120	120	30	2	4,5	8	4,80	50	400
6203.160	160	30	2	4,5	8	6,45	50	300
6203.200	200	30	2	4,5	8	8,15	50	300

## Plech spojovací PS4

**povrch:** galvanický zinkochromát (bílý) > 8µm  
**materiál:** ocel S235JR, pevn.tř.4.6, Re 235MPa



### Connecting plate PS4

**finish:** galvanized > 8µm  
**material:** forged steel St37-2

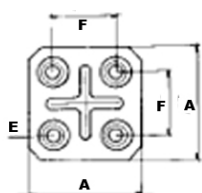

Kód Art. No.	A mm	D mm	E mm	F mm	děř holes	kg/100ks kg/100pcs	balení/ks bag/pcs	karton/ks carton/pcs
6204.40	40	1	4	25	4	1,00	100	2 000
6204.45	45	1	4	25	4	1,20	100	2 000

## Plech spojovací PS4

**povrch:** galvanický zinkochromát (bílý) > 8µm  
**materiál:** ocel S235JR, pevn.tř.4.6, Re 235MPa



### Connecting plate PS4

**finish:** galvanized > 8µm  
**material:** forged steel St37-2

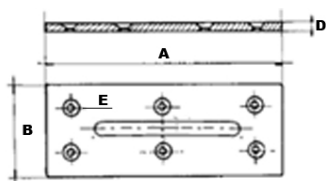

Kód Art. No.	A mm	B mm	D mm	E mm	děr holes	kg/100ks kg/100pcs	balení/ks bag/pcs	karton/ks carton/pcs
6204.50	50	40	1	4	4	1,50	100	1 500
6204.67	67	40	1	4	4	2,00	50	1 000
6204.86	86	40	1	4	6	2,40	50	800

## Plech spojovací PS5

**povrch:** galvanický zinkochromát (bílý) > 8µm  
**materiál:** ocel S235JR, pevn.tř.4.6, Re 235MPa

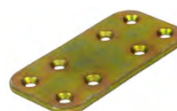

### Connecting plate PS5

**finish:** galvanized > 8µm  
**material:** forged steel St37-2

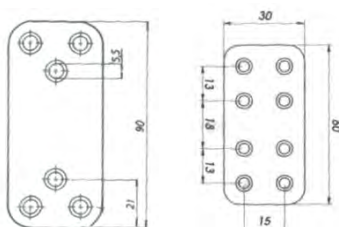

Kód Art. No.	A mm	B mm	D mm	E mm	děr holes	kg/100ks kg/100pcs	balení/ks bag/pcs	karton/ks carton/pcs
6205.60	60	30	2,0	4,5	8	2,40	100	1 000
6205.90	90	40	2,5	5,5	10	5,90	50	400

## Plech spojovací PS6

**povrch:** galvanický zinkochromát (žlutý) > 8µm  
**materiál:** ocel S235JR, pevn.tř.4.6, Re 235MPa



### Connecting plate PS6

**finish:** tropicalized > 8µm  
**material:** forged steel St37-2

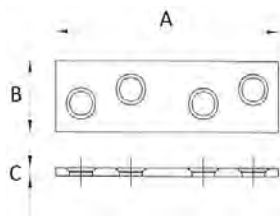

Kód Art. No.	A mm	B mm	C mm	Ø díra mm	děr holes	kg/100ks kg/100pcs	balení/ks bag/pcs	karton/ks carton/pcs
6206.50	50	15	1,8	4,0	4	2,40	100	1 000
6206.80	80	15	1,8	4,5	4	5,90	100	400

## Plech spojovací PS7

**povrch:** galvanický zinkochromát (bílý) > 8µm  
**materiál:** ocel S235JR, pevn.tř.4.6, Re 235MPa



### Connecting plate PS7

**finish:** galvanized > 8µm  
**material:** forged steel St37-2

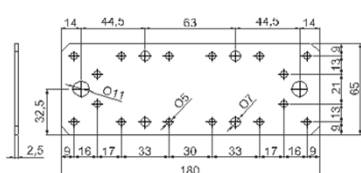

Kód Art. No.	A mm	B mm	D mm	díry Ø5,6,11 holes Ø5,6,11mm	kg/100ks kg/100pcs	balení/ks bag/pcs	karton/ks carton/pcs
6207.120	120	50	2,5	12, 0, 2	7,7	50	250
6207.160	160	50	2,5	12, 0, 2	11,3	25	200
6207.170	170	65	2,5	16, 4, 2	20,8	25	100
6207.200	200	90	2,5	30, 4, 2	39,8	10	50

**materiál:** nerezavějící ocel A4

**material:** stainless steel AISI 316

9207.200	200	90	3,0	30, 4, 2	39,8	10	50
----------	-----	----	-----	----------	------	----	----

## Patka kotevní U

**materiál:** ocel S275JR, pevn. tř. 5.6, Re 275MPa  
**povrch:** žárově pozinkováno > 40µm

### U plate anchor

**material:** forged steel St 44-2  
**finish:** hot dipped galvanized > 40µm

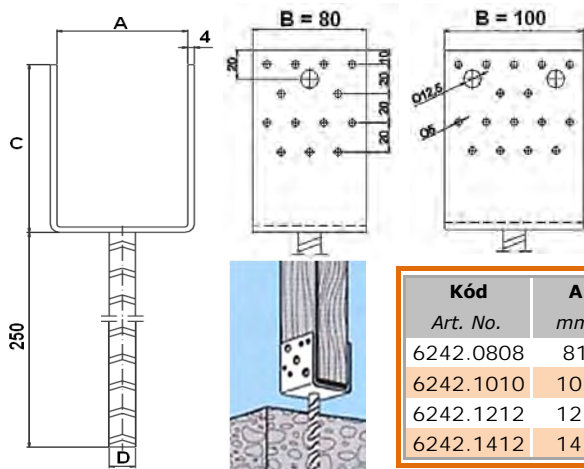

Kód Art. No.	A mm	B mm	C mm	D mm	plech plate	díry/holes Ø5 /12,5	kg/100ks kg/100pcs	balení/ks pack/pcs
6242.0808	81	80	125	16	4	26 / 2	116	4
6242.1010	101	100	125	16	4	32 / 4	135	4
6242.1212	121	120	125	20	4	40 / 4	180	2
6242.1412	141	120	125	20	4	40 / 4	193	2

## Patka kotevní L

**materiál:** ocel S275JR, pevn. tř. 5.6, Re 275MPa  
**povrch:** žárově pozinkováno > 40µm

### L plate anchor

**material:** forged steel St 44-2  
**finish:** hot dipped galvanized > 40µm

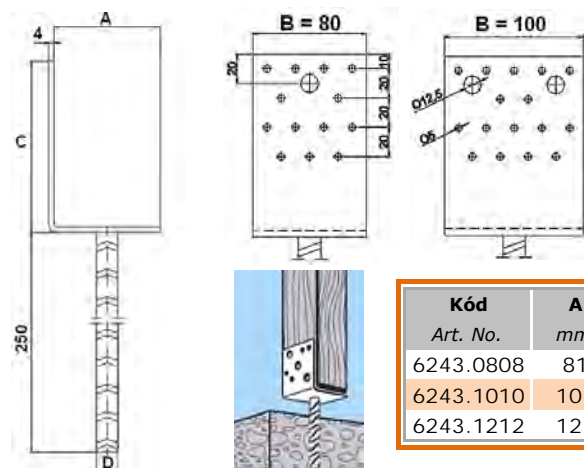

Kód Art. No.	A mm	B mm	C mm	D mm	plech plate	díry/holes Ø5 /12,5	kg/100ks kg/100pcs	balení/ks pack/pcs
6243.0808	81	80	125	16	4	26 / 2	105	4
6243.1010	101	100	125	16	4	32 / 4	120	4
6243.1212	121	120	125	20	4	40 / 4	170	2

## Profil kotevní s prolisem

**materiál:** ocel S275JR, pevn. tř. 5.6, Re 275MPa  
**povrch:** žárově pozinkováno > 40µm

### U plate anchor with molding

**material:** forged steel St 44-2  
**finish:** hot dipped galvanized > 40µm

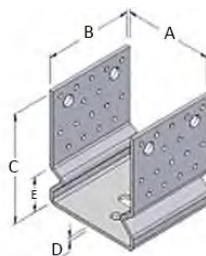
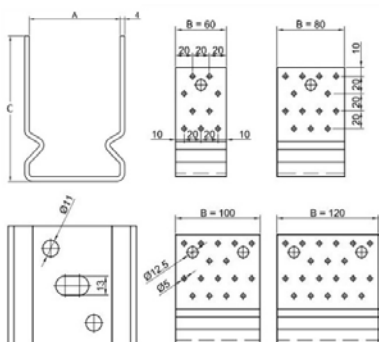

Kód Art. No.	A mm	B mm	C mm	D mm	E mm	díry/holes Ø5 /12,5	kg/100ks kg/100pcs	balení/ks pack/pcs
6241.0606	61	60	150	4	39	18 / 4	58	4
6241.0808	81	80	150	4	39	26 / 6	77	4
6241.1010	101	100	150	4	39	32 / 8	108	2
6241.1212	121	120	150	4	39	40 / 8	138	2

## Vrut zemní VZH

**materiál:** ocel S275JR, pevn. tř. 5.6, Re 275MPa  
**povrch:** žárově pozinkováno > 40µm

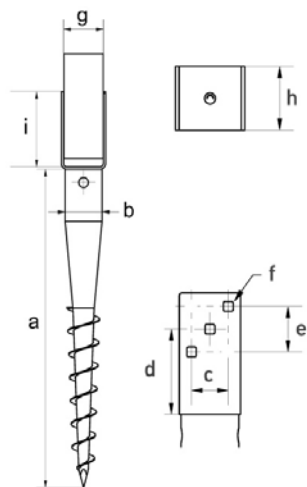

### Ground screw VZH

**material:** forged steel St 44-2  
**finish:** hot dipped galvanized > 40µm



Kód Art. No.	a mm	b mm	g mm	h mm	i mm	d / e mm	díry Ø10 holes Ø10	balení/ks pack/pcs
6260.080	550	68	81	75	135	75 / 85	6	4
6260.100	750	68	101	75	135	75 / 85	6	4
6260.120	750	68	121	75	135	75 / 85	6	4

## Vrut zemní VZM

**materiál:** ocel S275JR, pevn. tř. 5.6, Re 275MPa  
**povrch:** žárově pozinkováno > 40µm

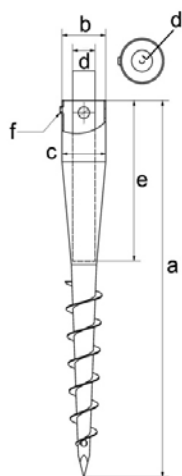

### Ground screw VZM

**material:** forged steel St 44-2  
**finish:** hot dipped galvanized > 40µm



Kód Art. No.	a mm	b mm	c mm	f mm	d mm	e mm	balení/ks pack/pcs
6262.560	560	68	65	M8	26/38/42/50/55	230	4



Uzávěry, petlice a rukojeti  
*Lever lock and latch*

## Uzávěř pákový UP1

povrch: galvanický zinkochromát  
materiál: ocel

### Lever locking UP1

finish: galvanized  
material: steel

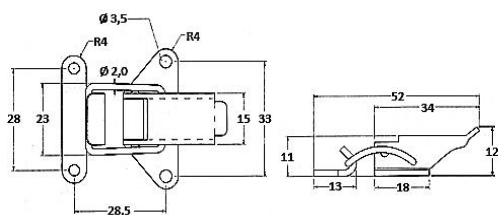

Kód Art. No.	rozměr viz. nákres v mm size see. drawing in mm	kg/100ks kg/100pcs	balení/ks bag/pcs	karton/ks carton/pcs
6801.45		2,2	20	200

## Uzávěř pákový uzamykatelný UP1

### Lever locking UP1 for padlock

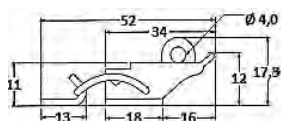

Kód Art. No.	rozměr viz. nákres v mm size see. drawing in mm	kg/100ks kg/100pcs	balení/ks bag/pcs	karton/ks carton/pcs
6801.45Z		2,3	20	200

## Uzávěř pákový UP2

povrch: galvanický zinkochromát  
materiál: ocel

### Lever locking UP2

finish: galvanized  
material: steel

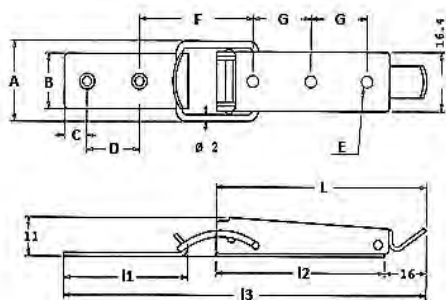

Kód Art. No.	A mm	B mm	C mm	D mm	kg/100ks kg/100pcs	balení/ks bag/pcs	karton/ks carton/pcs
6802.60	23	13	5	12	3,2	15	150
6802.90	34	19	8	20	6,3	5	50

## Uzávěř pákový uzamykatelný UP2

### Lever locking UP2 for padlock

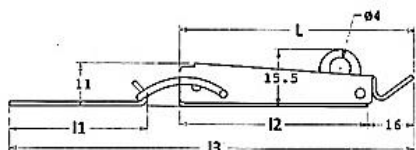

Kód Art. No.	L mm	I1 mm	I2 mm	I3 mm	kg/100ks kg/100pcs	balení/ks bag/pcs	karton/ks carton/pcs
6802.60Z	60	30	44	102	3,3	15	150
6802.90Z	86	43	70	140	6,4	5	50

## Uzávěř pákový UP4

povrch: galvanický zinkochromát  
materiál: ocel

### Lever locking UP4

finish: galvanized  
material: steel

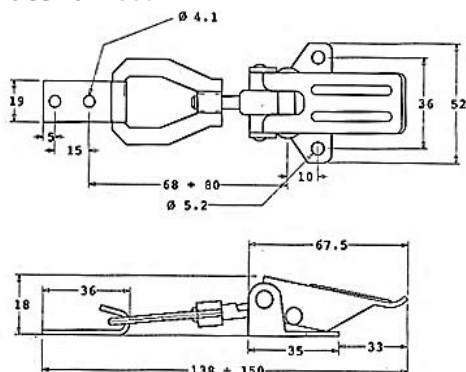

Kód Art. No.	rozměr viz. nákres v mm size see. drawing in mm	kg/100ks kg/100pcs	balení/ks bag/pcs	karton/ks carton/pcs
6804.95		9,8	5	150



## Uzávěř pákový UP5

**povrch:** galvanický zinkochromát  
**materiál:** ocel

**Lever locking UP5**

**finish:** galvanized  
**material:** steel

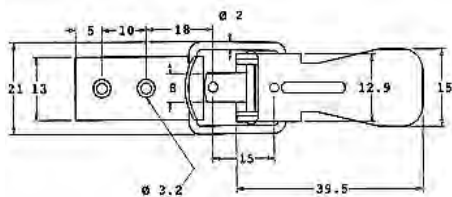

Kód Art. No.	rozměr viz. náčres v mm size see. drawing in mm	kg/100ks kg/100pcs	balení/ks bag/pcs	karton/ks carton/pcs
6805.49		1,7	20	200

## Petlice

**povrch:** galvanický zinkochromát  
**materiál:** ocel

**Hasp**

**finish:** galvanized  
**material:** steel

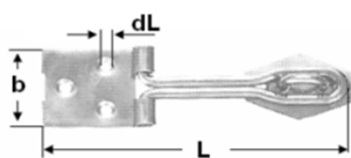

Kód Art. No.	L mm	b mm	dL mm	kg/100ks kg/100pcs	balení/ks bag/pcs	karton/ks carton/pcs
6350.080	80	26	3,7	2,7	20	500
6350.100	100	30	3,9	4,4	20	500
6350.120	120	30	4,2	5,5	10	300

## Petlice bezpečnostní

**povrch:** galvanický zinkochromát  
**materiál:** ocel

**Safety hasp**

**finish:** galvanized  
**material:** steel



Kód Art. No.	L mm	b mm	díry mm	kg/100ks kg/100pcs	balení/ks bag/pcs	karton/ks carton/pcs
6352.100	100	27	4,0	4,4	10	250
6352.120	120	27	4,2	4,8	10	200

## Rukojeť na bednu

**povrch:** galvanický zinkochromát  
**materiál:** ocel

**Crate handle**

**finish:** galvanized  
**material:** steel

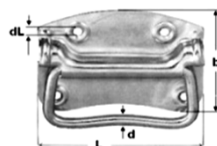

Kód Art. No.	L mm	b mm	dL mm	d mm	kg/100ks kg/100pcs	balení/ks bag/pcs	karton/ks carton/pcs
6840.090	90	67	4,2	6,8	4,4	12	240
6840.110	110	86	4,8	8,0	4,8	12	240

**povrch: černě lakovaná**

*painted black*



Kód Art. No.	L mm	b mm	dL mm	d mm	kg/100ks kg/100pcs	balení/ks bag/pcs	karton/ks carton/pcs
6841.090	90	67	4,2	6,8	4,4	12	240
6841.110	110	86	4,8	8,0	4,8	12	240



The background of the entire page is a collage of various textile products, including spools of thread, balls of yarn, and different types of fabric and rope, all rendered in a monochromatic green color scheme.

# Textilní lana a popruhy

---

## *Textile ropes and harness*

## Polyamidová lana a šňůry (PA)

Nízká odolnost vůči chemikáliím, neplavou na vodě, dobrá odolnost proti UV záření, nejvyšší pevnost, výborná oteřuvzdornost a absorpce rázových sil, vyšší tažnost. Vhodné jako lana vázací a tažná v dopravě, průmyslu a zemědělství, pro technické a sportovní účely.

### PA 8-pramenné, pletené s jádrem



**provedení:** bílá, barevná se vzorem

Kód Art. No.	Ø mm	barva colour	pevnost / kg strength / kg	kg/100m weight	cívka/m reel/m
PA08.08	8	bílá	1330	3,80	100
PA08.38	8	barevná	1330	3,80	100

### PA 16-pramenné, pletené s jádrem



**provedení:** bílá, barevná se vzorem

PA16.12	12	bílá	2850	10,60	50
PA16.42	12	barevná	2850	10,60	50

### PA 16-pramenné, pletené bez jádra



**provedení:** x = B-bílá, C-černá, K-khaki

PA16.x02	2	x	150	0,30	200
PA16.x03	3	x	250	0,55	100
PA16.x04	4	x	430	0,90	100
PA16.x05	5	x	610	1,30	100

## Polyesterová lana a šňůry (PES)

Odolná vůči chemikáliím, neplavou na vodě, stabilizovaná proti UV, vynikající pevnost, oteřuvzdornost, nízká tažnost, vysoká odolnost vůči povětrnostním vlivům. Vhodné pro vodní sporty, technické účely, zvedání břemen.

### PES šňůra technická 8-pr., pletená s jádrem



**provedení:** fluorescenční barvy x = O-oranžová, G-zelená, Y-žlutá

Kód Art. No.	Ø mm	barva colour	pevnost / kg strength / kg	kg/100m weight	cívka/m reel/m
PE08.02x	2	x	130	0,35	200
PE08.03x	3	x	210	0,70	100
PE08.04x	4	x	350	1,10	100

### PES šňůra 12-pramenná, pletená bez jádra



**provedení:** bílá - žaluziová

PE12.12	1,2	bílá	40	0,12	250
PE12.14	1,4	bílá	50	0,17	250

### PES šňůra technická 16-pr., pletená s jádrem



**provedení:** bílá s pružkem, barevná se vzorem

PE16.02	2	bílá	130	0,35	200
PE16.03	3	bílá	210	0,70	200
PE16.04	4	bílá	350	1,10	100
PE16.05	5	bílá	510	1,55	100
PE16.06	6	bílá	620	2,55	100
PE16.22	2	barevná	130	0,35	200
PE16.23	3	barevná	210	0,70	200
PE16.24	4	barevná	350	1,10	100
PE16.25	5	barevná	510	1,55	100
PE16.26	6	barevná	620	2,55	100

**provedení:** signální - pro vodní sporty

PE16.62	2	signální	130	0,35	200
PE16.63	3,5	signální	260	0,80	100
PE16.65	5	signální	510	1,80	100

### PES šňůra reflexní 16-pr., pletená s jádrem



**reflexní barvy s tečkou (x) = G-zelená, O-oranž., R-růžová, Y-žlutá**

PE16.F2x	2	G-zelená	130	0,35	200
PE16.F3x	3	O-oranž.	210	0,70	200
PE16.F4x	4	R-růžová	350	1,10	100
PE16.F5x	5	Y-žlutá	510	1,55	100

## Polypropylénová lana a šňůry (PP Multitex)

Odolná vůči chemikáliím, neplavou na vodě, stabilizovaná proti UV, vynikající pevnost, ořezuvzdornost, nízká tažnost, vysoká odolnost vůči povětrnostním vlivům.

Vhodné pro vodní sporty, technické účely, zvedání břemene. Odolná vůči chemikáliím, plavou na vodě, stabilizovaná proti UV záření, dobrá pevnost, výborná ořezuvzdornost, uzlovatelnost.

**Univerzální použití.** Polypropylénové vlákno "Multitex"

### PP lano 8-pramenné, pletené bez jádra



**provedení:** bílé, barevné, vzorované

Kód Art. No.	Ø mm	pevnost / kg strength / kg	kg/100m weight	cívka/m reel/m
PP08.02	2	80	0,25	200
PP08.03	3	160	0,50	200
PP08.04	4	250	0,70	100
PP08.05	5	340	0,95	100
PP08.06	6	440	1,40	100
PP08.08	8	640	2,45	100
PP08.10	10	900	3,65	100
PP08.12	12	1250	4,80	100
PP08.14	14	1450	7,30	50

### PP lano 12-pramenné, spirálově pletené



**provedení:** černá+červená / béžová / modrá

Kód Art. No.	Ø mm	pevnost / kg strength / kg	kg/100m weight	cívka/m reel/m
PP12.08	8	700	3,30	100
PP12.10	10	1000	4,00	100
PP12.12	12	1350	5,50	100
PP12.14	14	1600	7,50	50

### PP lano 16-pramenné, pletené s jádrem



**provedení:** bílá s pružkem, barevné, vzorované

Kód Art. No.	Ø mm	pevnost / kg strength / kg	kg/100m weight	cívka/m reel/m
PP16.04	4	320	0,85	100
PP16.05	5	400	1,15	100
PP16.06	6	510	1,80	100
PP16.07	7	640	2,30	100
PP16.08	8	860	3,40	100
PP16.09	9	1050	4,20	100

### PP lano 32-pramenné, pletené s jádrem



**provedení:** technické lano barevné, vzorované

Kód Art. No.	Ø mm	pevnost / kg strength / kg	kg/100m weight	cívka/m reel/m
PP32.08	8	1000	3,1	100
PP32.10	10	1450	4,6	100
PP32.12	12	2200	7,0	50

### Gumolano s pryžovým jádrem, PP oplet



**provedení:** černé, barevné, vzorované

Kód Art. No.	Ø mm	pružnost % elasticity %	kg/100m weight	cívka/m reel/m
G165.04	4	115%	1,2	100
G165.05	5	130%	1,5	100
G165.06	6	130%	2,3	100
G165.08	8	100%	4,0	100
G165.09	9	110%	4,8	50
G165.10	10	110%	7,1	50
G165.12	12	110%	11,6	50

### Hák na gumolana



**provedení:** černě lakovaný, pozink

Kód Art. No.	díra mm	Ø lana mm	kg/100ks kg / 100pcs	ks/balení pcs/pack
G326.06	7	4 - 6	1,0	50
G326.08	9	6 - 8	1,3	50
G326.10	11	8 - 10	2,0	50

## Stáčená lana z přírodních materiálů

Jutová, sisalová lana a motouzy nejsou odolné vůči kyselinám, odolávají zásaditým látkám, omezená pevnost, nízká oděruvzdornost a odolnost vůči UV záření.

**Uplatnění** ve stavebnictví, zemědělství, lesnictví, vhodné k dekorativním a sportovním účelům.

### Juta/PP lano 4-pr., stáčené



Kód Art. No.	Ø mm	balení packing	pevnost / kg strength / kg	kg/100m weight	cívka/m reel/m
JPO4.04	4	cívka	180	1,3	100
JPO4.06	6	cívka	220	2,2	100
JPO4.08	8	cívka	480	3,9	100
JPO4.10	10	cívka	620	4,8	100
JPO4.12	12	cívka	980	7,7	100
JPO4.14	14	cívka	1740	12,0	50
JPO4.16	16	cívka	2590	14,4	50
JPO4.20	20	cívka	3520	20,3	35
JPO4.24	24	svazek	4590	28,5	30
JPO4.30	30	svazek	5710	40,0	20
JPO4.36	36	svazek	7140	64,0	15

### JUTA motouz



Kód Art. No.	1ks / g 1pc / g	kg/100ks kg/100pcs	balení / ks pack / pcs
MJ27.05	50	5	20
MJ27.10	100	10	10
MJ27.20	200	20	6
MJ27.50	500	50	1

### LEN motouz potravinářský



Kód Art. No.	1ks / g 1pc / g	kg/100ks kg/100pcs	balení / ks pack / pcs
ML28.04	40	4	10

### PP motouz



Kód Art. No.	1ks / g 1pc / g	kg/100ks kg/100pcs	balení / ks pack / pcs
MP29.05	50	5	20
MP29.10	100	10	10
MP29.25	250	25	6
MP29.50	5000	500	1

### PP zednická šňůra, pletená bez jádra



**provedení:** žlutá, zelená, červená

Kód Art. No.	Ø mm	pevnost / kg strength / kg	kg/100m weight	cívka/m reel/m
PP12.02	1,8	40	0	50

## Polypropylénové popruhy

Vysoká pevnost, nenasákavost, stabilizace proti UV záření, využití pro sportovní výstroj, batohy, chovatelské potřeby - vodítka, obojky, lemování textilních výrobků, výplety nábytku, saní apod. manipulace s břemeny

### PP Popruh, jednovrstvý univerzální

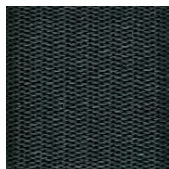



**provedení: černý**

Kód Art. No.	Ø mm	pevnost / (N) strength / (N)	kg/100m weight	návin / m pack / m
PU25.16	16	2000	1,10	50
PU25.20	20	3300	1,28	50
PU25.25	25	4000	1,60	50
PU25.30	30	5000	1,96	50
PU25.40	40	6200	2,84	50
PU25.50	50	8000	3,90	50

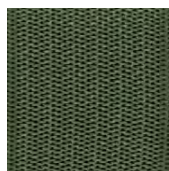

**provedení: khaki**

PU26.20	20	3300	1,28	50
PU26.25	25	4000	1,60	50
PU26.30	30	5000	1,96	50
PU26.40	40	6200	2,84	50



**provedení: červený**

PU27.20	20	3300	1,28	50
PU27.25	25	4000	1,60	50
PU27.30	30	5000	1,96	50
PU27.40	40	6200	2,84	50

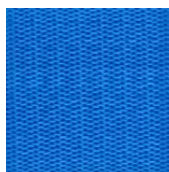

**provedení: modrý**

PU28.20	20	3300	1,28	50
PU28.25	25	4000	1,60	50
PU28.30	30	5000	1,96	50
PU28.40	40	6200	2,84	50

### PP Popruh, jednovrstvý fluorescenční

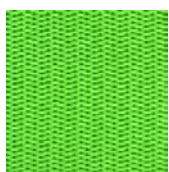

**provedení: zelený**

Kód Art. No.	Ø mm	pevnost / (N) strength / (N)	kg/100m weight	návin / m pack / m
PF25.20	20	3300	1,28	50
PF25.25	25	4000	1,60	50
PF25.30	30	5000	1,96	50
PF25.40	40	6200	2,84	50

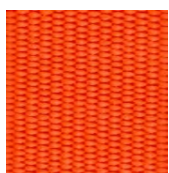

**provedení: oranžový**

PF26.20	20	3300	1,28	50
PF26.25	25	4000	1,60	50
PF26.30	30	5000	1,96	50
PF26.40	40	6200	2,84	50

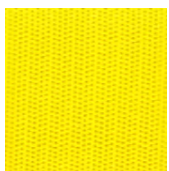

**provedení: žlutý**

PF27.20	20	3300	1,28	50
PF27.25	25	4000	1,60	50
PF27.30	30	5000	1,96	50
PF27.40	40	6200	2,84	50

## Polypropylénové popruhy

### PP(pásek) popruh čalounický

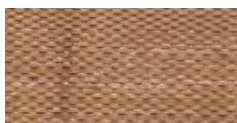

**provedení:** béžový

Kód Art. No.	Ø mm	pevnost / (N) strength / (N)	kg/100m weight	návin / m pack / m
PC01.50	50	8500	2,00	50
PC01.60	60	10000	2,30	50



**provedení:** béžový s pruhy

PC03.40	40	6000	1,64	50
PC03.50	50	8500	2,05	50
PC03.60	60	9000	2,35	50

### PP popruh na sáňky



**provedení:** hnědo - oranžový

Kód Art. No.	Ø mm	pevnost / (N) strength / (N)	kg/100m weight	návin / m pack / m
PS01.60	60	10000	3,10	50

**provedení:** modro - žlutý

PS02.60	60	10000	3,10	50
---------	----	-------	------	----

**provedení:** černo - žlutý

PS03.60	60	9000	3,10	50
---------	----	------	------	----

### PP Popruh, výcevrstvý

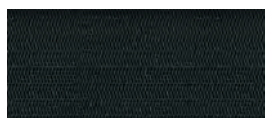

**provedení:** černý

Kód Art. No.	Ø mm	pevnost / (N) strength / (N)	kg/100m weight	návin / m pack / m
PV65.20	20	7000	2,08	50
PV65.25	25	9500	2,70	50
PV65.30	30	12000	3,40	50

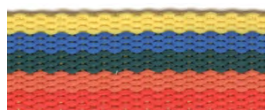

**provedení:** duhový

PV66.25	25	9000	2,43	50
---------	----	------	------	----



**provedení:** červený s pruhy

PV67.20	20	6400	2,08	50
PV67.25	25	7500	2,70	50
PV67.30	30	10000	3,40	50



**provedení:** modrý s pruhy

PV68.20	20	6400	2,08	50
PV68.25	25	7500	2,70	50
PV68.30	30	10000	3,40	50



**provedení:** maskáč

PV75.20	20	6500	2,08	50
PV75.25	25	8500	2,70	50



**provedení:** maskáč

PV76.25	25	8000	2,70	50
---------	----	------	------	----